



## INSTALLATION GUIDE: AWE F150 EXHAUST

For up-to-date fitment information, please visit the product page on [AWE-Tuning.com](http://AWE-Tuning.com).

\*This product is not confirmed to fit the 122" wheelbase model (i.e. Regular Cab with 5.5 ft. bed)

### THIS GUIDE IS INTENDED FOR THE FOLLOWING PART NUMBERS:

3015-11048 AWE Resonated Front Section For F-150

3020-11026 AWE Non Resonated Front Section For F-150

3015-22066 AWE Single Side Exhaust For F150 - Chrome Silver Tips

3015-23058 AWE Single Side Exhaust For F150 - Diamond Black Tips

3015-32104 AWE Dual Rear Exit Exhaust For F-150 - Chrome Silver Tips

3015-33120 AWE Dual Rear Exit Exhaust For F-150 - Diamond Black Tips

Welcome to the AWE family, and congratulations on your purchase of the AWE Exhaust system for the Ford F-150.

Exquisite build quality and craftsmanship, coupled with industry leading performance, distinguish this exhaust system from all others.

\*For up to the minute fitment information, be sure to visit the AWE website. As always, AWE Performance Specialists are standing by for any questions, [right here](#).

**Thank you for purchasing the AWE Touring Edition Exhaust!**

Copyright 2018, AWE. No part of this document may be reused or duplicated without the express permission of AWE/Secor Ltd. All rights reserved. Rev1.3

\*For up to the minute fitment information, be sure to visit the AWE website. As always, AWE Performance Specialists are standing by for any ques-

# PARTS LIST



**INSPECT ALL PARTS PRIOR TO DISASSEMBLY OF VEHICLE; IF DAMAGED OR MISSING, PLEASE CONTACT THE PLACE OF PURCHASE IMMEDIATELY.**

## PERFORMANCE MID PIPES (SOLD SEPARATELY)

QTY	Description	Part Number
1	164" Wheelbase Adapter	C14
1	3.00in Accu-Seal Clamp	TAS300
<b>Resonated System Only</b>		
1	Ford F-150 13G Resonated Inlet	C10
<b>Non Resonated System Only</b>		
1	Ford F-150 13G Non Resonated Inlet	C11

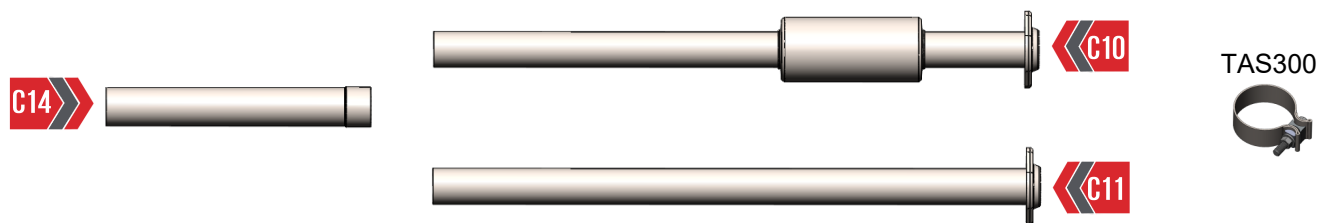

## SINGLE EXIT EXHAUST SYSTEMS

QTY	Description	Part Number
1	Ford F-150 13G OEM Resonator Adapter	C12
1	Ford F-150 13G HR Mid Section	C15
1	Ford F-150 13G Single Outlet Axle Tube	C16
1	Ford F-150 13G Single Outlet Rear Merge	C17
5	3.00in Accu-Seal Clamps	TAS300
2	4.5" Slash Cut Tip	61000488 (Black) or 61000455 (Chrome)

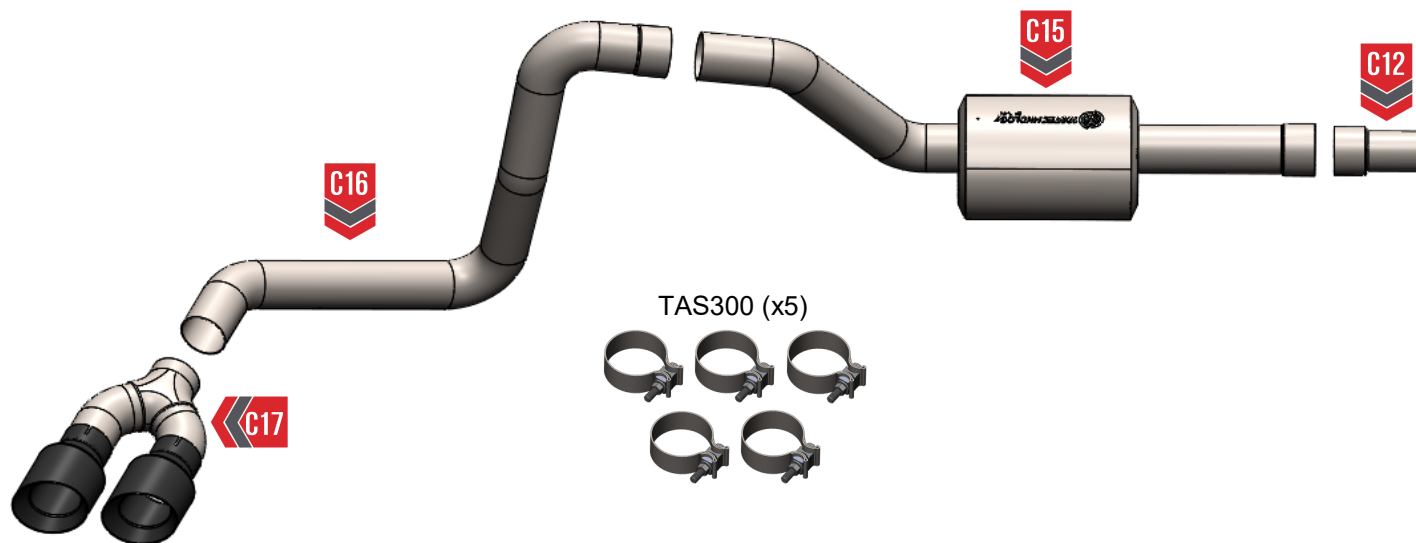

# PARTS LIST

## DUAL EXIT EXHAUST

QTY	Description	Part Number
1	Ford F-150 13G OEM Resonator Adapter	C12
1	Ford F-150 13G HR Mid Section	C15
1	Ford F-150 13G Dual Outlet Mid Merge	C18
1	Ford F-150 13G Dual Outlet Driver Side Axle Tube	C19
1	Ford F-150 13G Dual Outlet Passenger Side Axle Tube	C20
2	Ford F-150 13G Dual Outlet Side Exit Tip Outlets	C21
1	Ford F-150 13G Dual Outlet Driver Side Rear Tip Outlet	C22
1	Ford F-150 13G Dual Outlet Passenger Side Rear Tip Outlet	C23
2	Ford F-150 13G Dual Outlet Universal Hanger	C24
2	5" Straight Cut Tip	180003BC (Black) or 180003CHROME (Chrome)
8	3.00in Accu-Seal Clamps	TAS300
2	F-150 Universal Hanger Bracket-Backing	110035
2	Rubber Exhaust Isolator	610400
1	Hanger hardware kit	3910-41022
2	1/2" exhaust hanger split collar	1C-050-A
2	1/2" Hanger clamp Kit	3910-11012
1	9/64" Allen Wrench	7122A19
4	M8-1.25 x 30mm Socket Head Cap Bolt	91287A154
4	M8-1.25 Locknut	91828A410
4	M8 Stainless Steel Lock Washer	92148A200

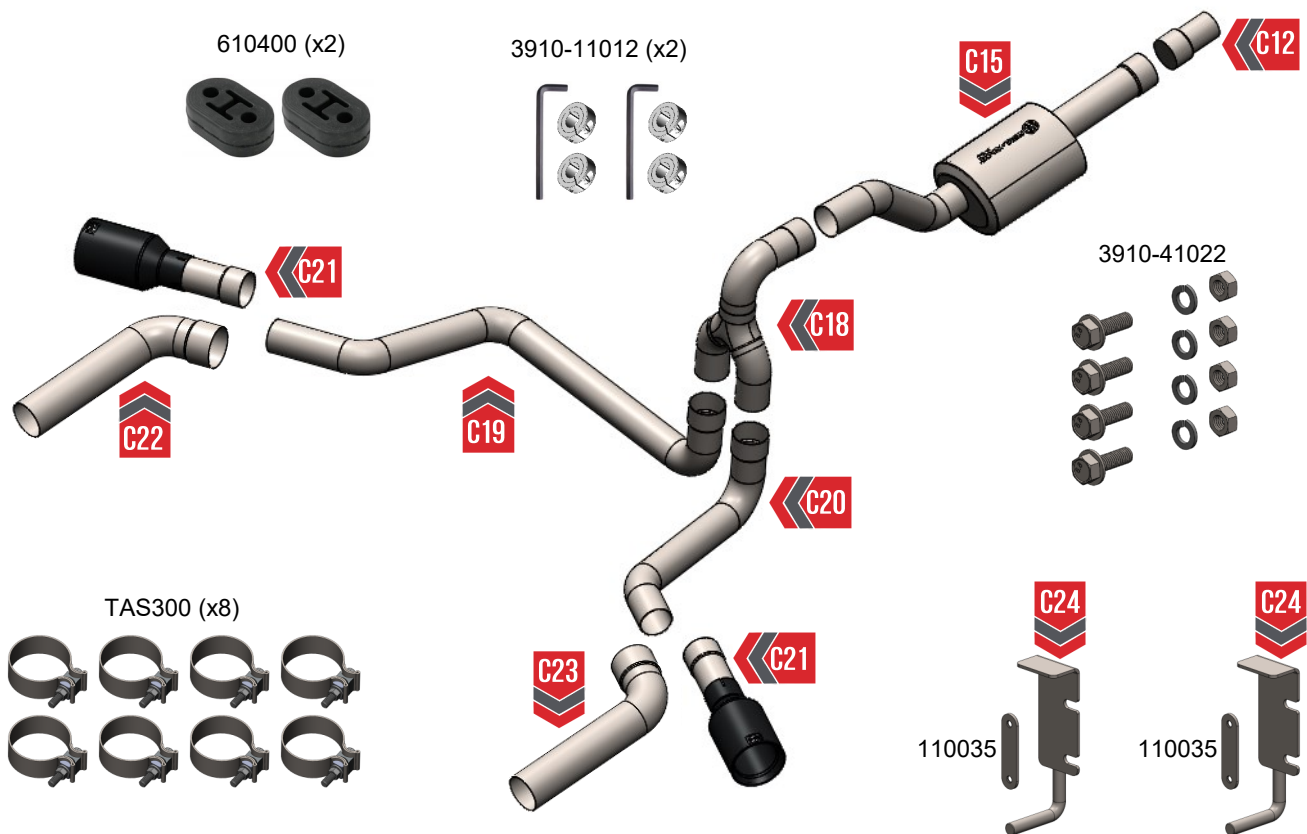



**NOTE:** Always refer to the manufacturer's service manual for precise torque specifications on all OEM fasteners.



**CAUTION:** The exhaust may be **VERY HOT** — allow adequate time for the system to cool down before disassembly. Severe burns and injury will occur if skin comes into contact with a hot exhaust system.

## STEP 1

Start by loosening the front two flange bolts connecting the resonator section to the resonator inlet shown in **Figure 1**. These must move freely to detach the rest of the exhaust system.

If you will also be installing the performance resonator section, you can remove this hardware to be re-used when installing your AWE Exhaust system

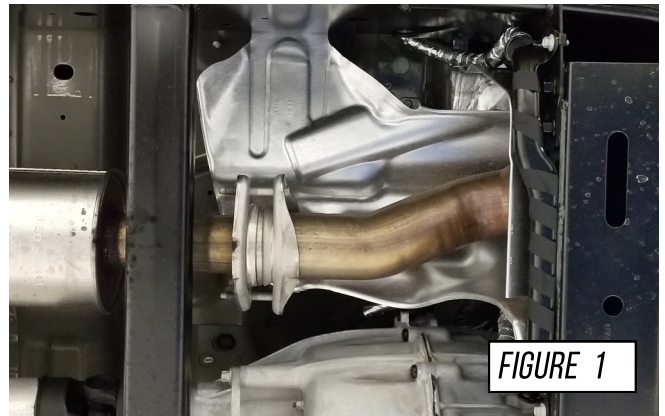

FIGURE 1

## STEP 2

Loosen the factory clamp **(A)** holding the resonator section to the over axle tube shown in **Figure 2**

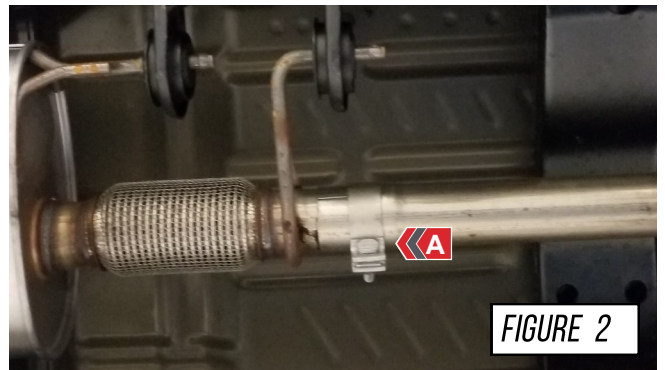

FIGURE 2

## STEP 3

The resonator section and over axle section are held in place by the locking feature shown in **Figure 3**.

While facing the front of the vehicle, rotate the front resonator section clockwise to release the locking feature.

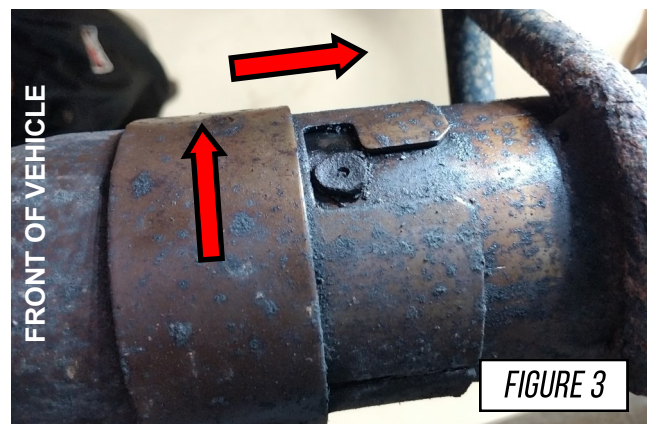

FIGURE 3

## STEP 4

Remove the two front hanger brackets from the truck as shown in **Figure 4**. This will aid in removal of the OE system,

**NOTE:** Hanger Brackets vary between the different motors. But the instructions remain the same.

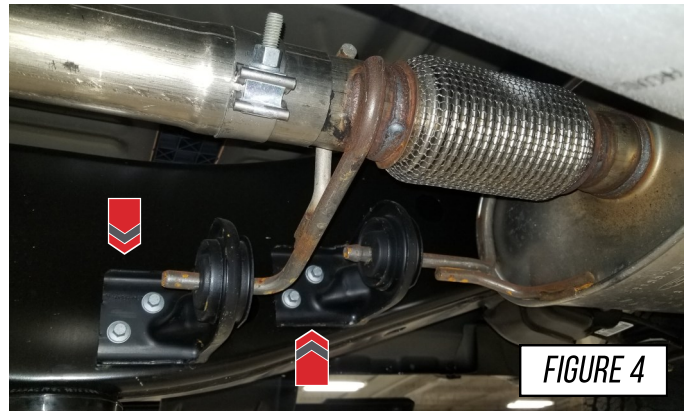

FIGURE 4

## STEP 5

Remove the first rear hanger, this will be reused in the AWE systems install, **Figure 5**

**NOTE:** The OEM exhaust system should be safely supported before disassembly

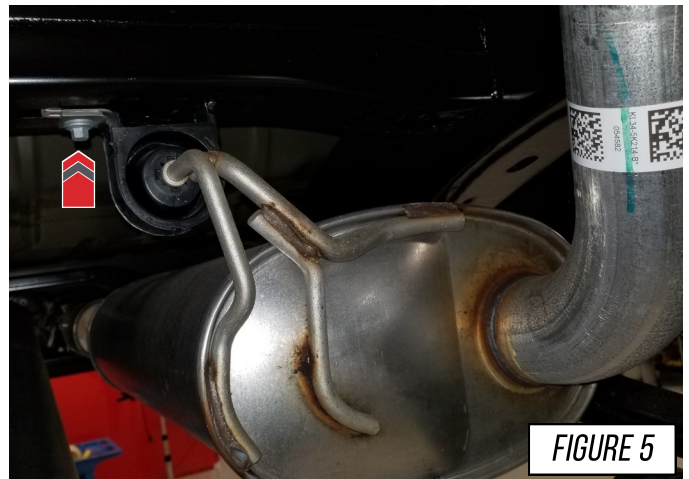

FIGURE 5

## STEP 6

Remove the last rear hanger, this will be reused in the AWE systems install, **Figure 6**

Confirm that the front section is disconnected and remove the OEM exhaust system from the vehicle.



FIGURE 6

## STEP 7

### Reinstalling the factory exhaust hangers:

All of the exhaust hanger brackets on the v8 models can be reinstalled into their factory locations.

For the Eco boost models, both rear hangers, previously removed in steps 5 and 6 can be reinstalled. Reinstall the hanger bracket marked **(a)** in **Figure 7**. The front-most hanger bracket denoted **(b)** will not be re-used.

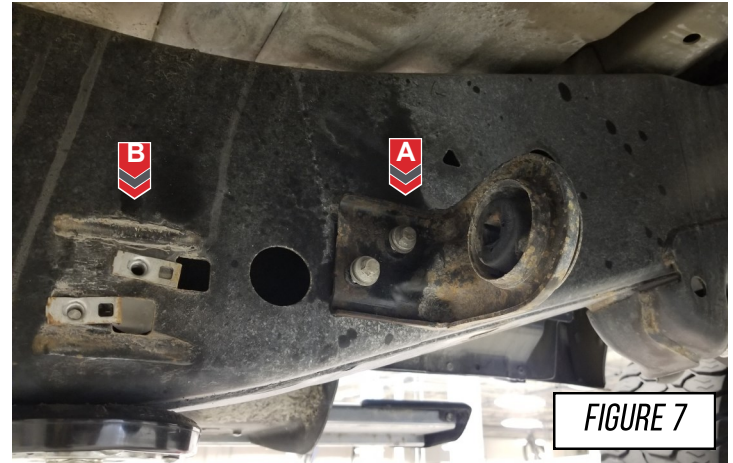

FIGURE 7

## STEP 8

### AWE Performance Resonator Section:

Begin by installing the new AWE resonated inlet section (C10) or non resonated inlet section (C11) with the factory front flange hardware as shown in **Figure 8-1**

**NOTE:** The Performance mid-section includes an adapter (part C14) to be used with the 164" wheelbase vehicles shown in **Figure 8-2**. This part is may not be required for all vehicles.



FIGURE 8-1

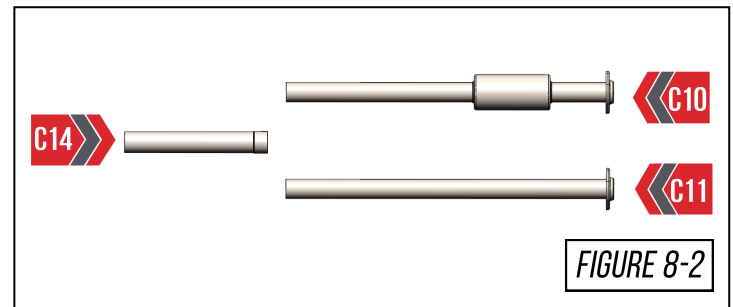

FIGURE 8-2

## STEP 9

It is crucial to install each section and Accu-Seal clamp correctly to prevent loose joints, exhaust leaks between the tubing connections, and rattles.

**Arrow A** in **Figure 9** shows the expanded pipe and the preinstalled Accu-Seal clamp being brought up to the corresponding pipe.

**Arrow B** in **Figure 9** shows the overlapping pipe installed correctly over the corresponding pipe.

**Arrow C** in **Figure 9** shows the Accu-Seal clamp being brought to the edge of the expanded pipe.

### NOTES:



- **Do not** torque any Accu-Seal clamp until the entire exhaust has been installed and adjusted.
- Torque specification is a minimum of 60 ft/lbs

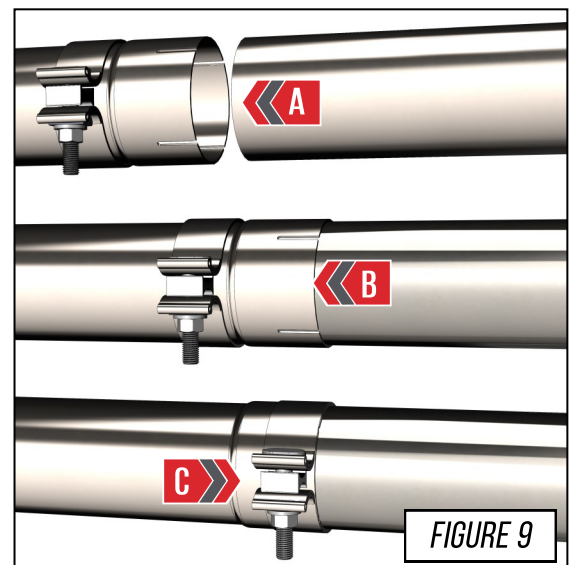

FIGURE 9

## STEP 10

### AWE Axle-Back Exhaust System:

Installation of the AWE axle-back system requires the use of the axle-back adapter (**C12**). This adapter will attach to the factory resonator section and fastened using the connected factory clamp shown in **Figure 8-2**.

Install the AWE Mid Section (part **C15**) by securing the hanger bars into their respective brackets, then slip one of the supplied 3.0" Accu-Seal clamps over the inlet end and connect it to the outlet of the preceding tube. **Figure 9**

**NOTE:** If installing the axle-back system, use the C12 adapter to join part **C15** with the Factory

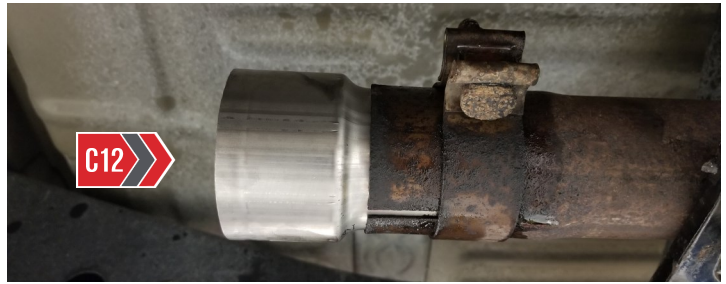

**IF INSTALLING THE DUAL OUTLET SYSTEM, SKIP TO STEP 13  
IF INSTALLING THE SINGLE OUTLET SYSTEM CONTINUE TO STEP 11**



## STEP 11

Continue by installing the single outlet axle-tube (part **C16**). Slide a 3.0" Accu-Seal clamp over the inlet end of the axle tube (**A**) and connecting it to the outlet of the mid section. Secure the tube into its factory hanger (**B**). **Figure 11**



## STEP 12

Install the single outlet rear merge (part **C17**) onto the axle tube using one of the supplied 3.0" Accu-Seal clamps, make sure to put the clamp on the tube before sliding the merge on. **Figure 12**

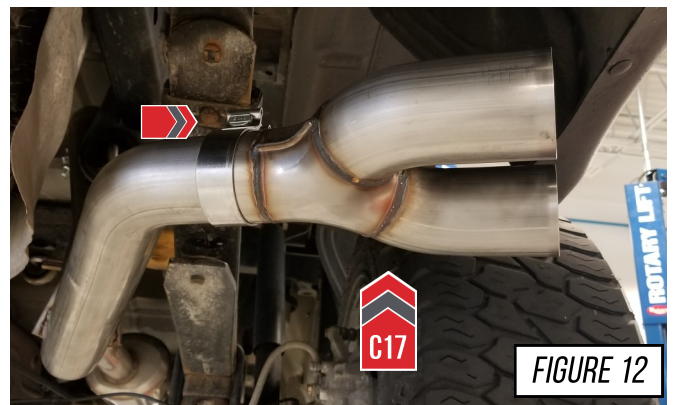

**SKIP TO STEP 19 FOR TIP INSTALLATION INSTRUCTIONS**



## STEP 13

Install the **dual outlet** mid merge (part **C18**) onto the mid section outlet using a supplied 3.0" Accu-Seal clamp. **Figure 13**

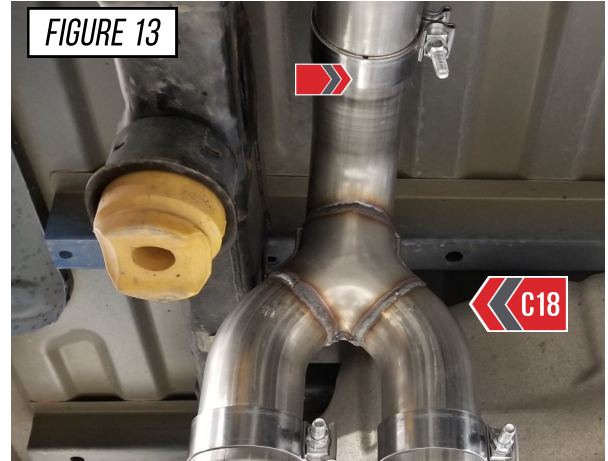

## STEP 14

Before the rear axle tubes can be installed, the new universal hangers (part C24) must be installed

Start by installing the supplied bolts into the threaded backer bracket (part **110035**), shown in **Figure 14-1**. Make sure these are securely fastened.

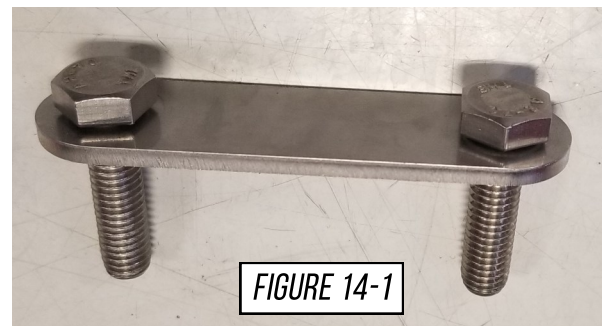

Locate the holes that the bracket is inserted into. These holes are the same on each side and have two indicators of their location, the welded frame support **(A)** and the triangular cutout in the frame **(B)**, **Figure 14-2**. Insert the backer bracket into the designated spot, **Figure 14-3**.

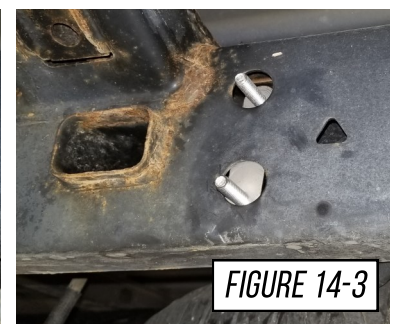
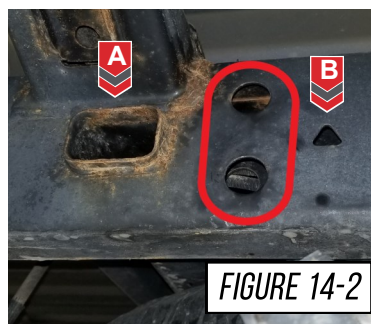

Slide the universal hanger bracket into place and thread on the lock washers and nuts (**Figure 14-4**). Repeat on both sides of the vehicle.

**NOTE:** Ensure that the universal hanger bar is pointing towards the inside of the frame and spare tire.

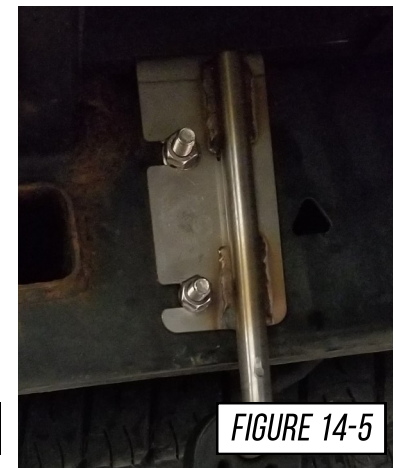
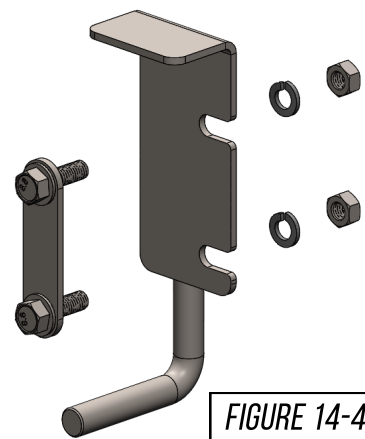



## STEP 15

Install the rear axle tubes, Drivers side (part **C19**) and passenger side (part **C20**). Use the supplied 3.0" Accu-Seal Clamps (**A**) and rubber exhaust isolators (**B**) shown in **Figure 15**.

If installing the dual outlet exhaust the rear factory hanger will not be used. It can be removed, but it will not be in the way of the AWE system



FIGURE 15



**IF INSTALLING THE REAR EXIT EXHAUST SYSTEM, SKIP TO STEP 17**  
**IF INSTALLING THE SIDE EXIT EXHAUST SYSTEM CONTINUE TO STEP 16**



## STEP 16

Install the rear tip outlets for the system onto the rear axle tubes using the provided 3.0" Accu-Seal clamps. **Figure 16**

The two tip outlets (part **C21**) are not side specific

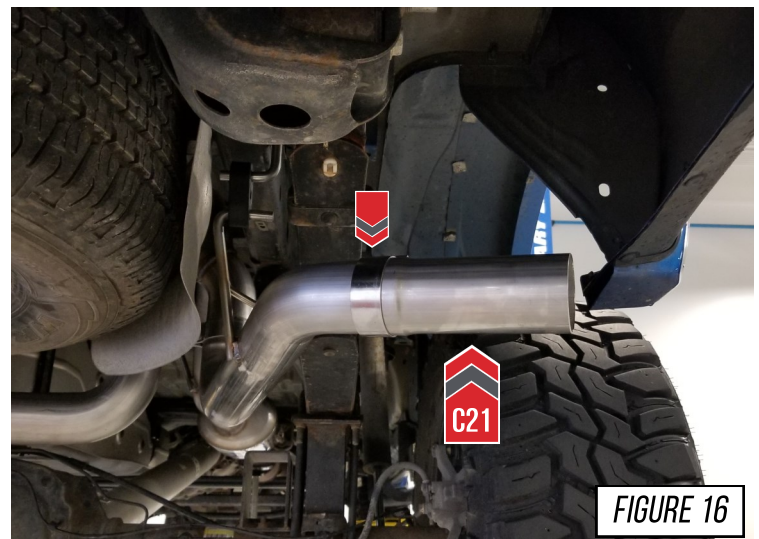

FIGURE 16



**SKIP TO STEP 19 FOR TIP INSTALLATION INSTRUCTIONS**



## STEP 17

Install the drivers side tip outlet (part **C22**) for the system onto the drivers side rear axle tube using the provided 3.0" Accu-Seal clamp. **Figure 17**. Repeat for the passenger side tube (part **C23**).

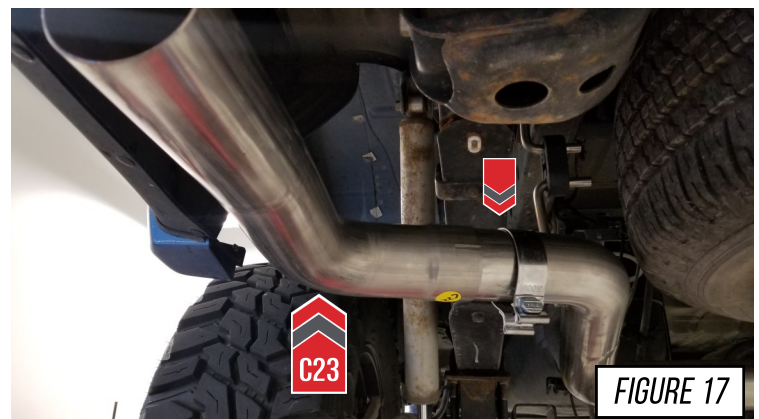
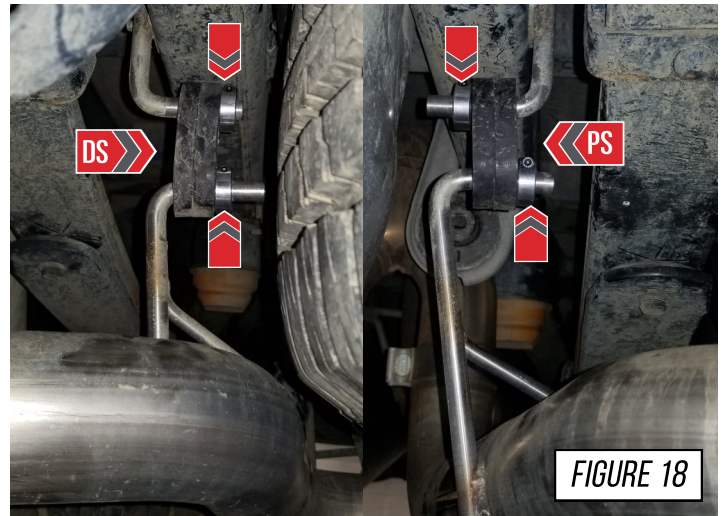

FIGURE 17

## STEP 18

Install the exhaust hanger split collars and included Allen wrench to help keep the exhaust system aligned and secure. Install these clamps in the orientation shown in **Figure 18**.



## STEP 19

### **AWE exhaust system tip installation:**

For **single side** exit exhaust systems, install the tips using two of the supplied 3-inch Accu-Seal clamps (TAS300) to the same specifications outlined in **Step 9**.

**Note:** The tip angle will follow the contour of the truck bed, with the logo on top.

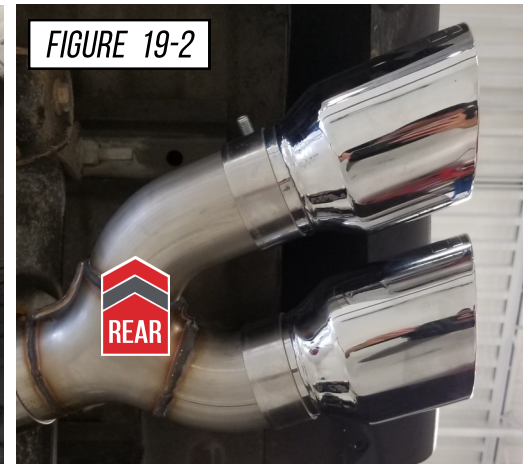
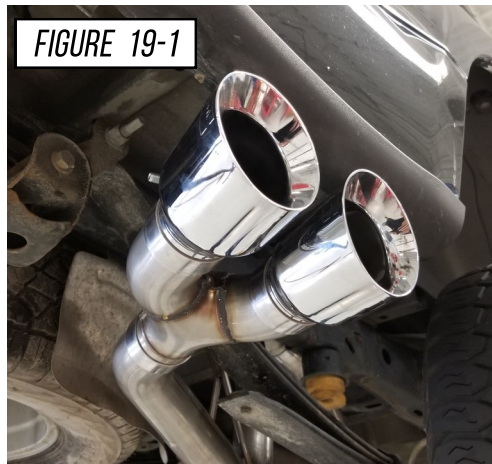

For **dual side** tip outlets, use the supplied 3-inch Accu-Seal Clamps (TAS300) to install the 5" straight cut tips to the same specifications outlined in **Step 9**.

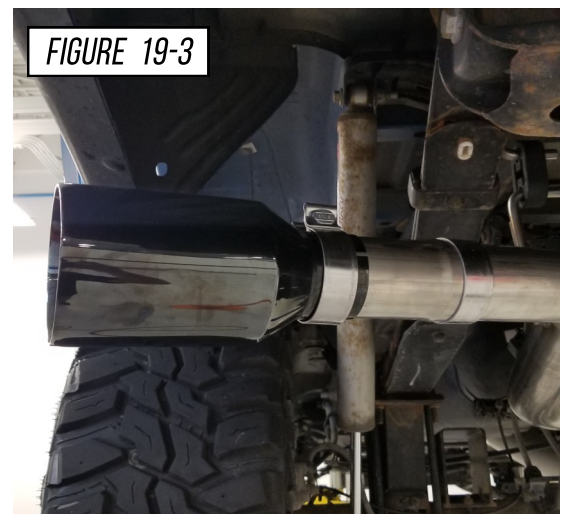

# ENJOY!



# TROUBLESHOOTING

Issue	Solution
Exhaust is not fitting correctly	Most fitment issues are due to improperly adjusted exhaust. This includes tip fitments and rattling due to chassis contact. Check out our <a href="#">fitment guide</a> for more installation tips.
Wrong or missing parts	Double check the parts list for your system and compare them with what you received. Fill out our contact form, found below and let us know what parts you need.

# CARE

Once installed properly, your AWE exhaust will provide years of trouble-free performance.

The exhaust volume and sound will settle with usage; 800-1000 miles is required to break-in new exhaust systems.

Also, please note that the rear **180Technology®** resonator has a small drain hole to allow condensation to escape. Water drops from this area are normal.

Periodic cleaning of exhaust tips is necessary to maintain proper finish, especially in areas prone to road salt and caustic deicing solutions. Use a mild soap and water solution or car wax to clean the finish. Avoid using abrasive polishes, as they can scratch the finish.

Any questions or comments,  
please do not hesitate to contact us:

**AWE**  
215-658-1670  
[CONTACT FORM](#)

# WARRANTY

Up-to-date warranty information is found [HERE](#).