



AWE HONDA CIVIC TYPE R TRACK AND TOURING EXHAUST INSTALLATION GUIDE:

For up-to-date– information, please visit the product’s page on [AWE-Tuning.com](https://www.awe-tuning.com).

THIS GUIDE IS INTENDED FOR THE FOLLOWING PART NUMBERS:

3020-52000 AWE Track Edition Exhaust for FK8 Civic Type R - Triple Chrome Silver Tips

3020-53002 AWE Track Edition Exhaust for FK8 Civic Type R - Triple Diamond Black Tips

3015-52004 AWE Touring Edition Exhaust for FK8 Civic Type R - Triple Chrome Silver Tips

3015-53006 AWE Touring Edition Exhaust for FK8 Civic Type R - Triple Diamond Black Tips

Welcome to the AWE family, and congratulations on your purchase of the AWE Exhaust system for the Civic Type R.

Exquisite build quality and craftsmanship, coupled with industry leading performance, distinguish this exhaust system from all others.

*For up to the minute fitment information, be sure to visit the AWE website. As always, AWE Performance Specialists are standing by for any questions, [right here](#).

Thank you for purchasing the AWE Touring Edition Exhaust!

*For up to the minute fitment information, be sure to visit the AWE website. As always, AWE Performance Specialists are standing by for any questions, [right here](#).

PARTS LIST



Inspect **ALL** parts prior to disassembly of vehicle; If damaged OR **MISSING**, please contact the place of purchase immediately.

Honda Civic Type R

QTY	Description	Part Number
1	Honda Civic 10G Type R 2.0L front pipe	C26
1	Honda Civic 10G Type R resonated section	C28
1	Honda Civic 10G Type R mid section	C29
4	3.00in ACCU-SEAL	TAS300
1	Honda Civic 10G triple tip outlet CTR/Si coupe	C35
3	114mm exhaust tip	61000078 (chrome) or 61000078-BLK (black)
3	Barrel hardware clamp	BHM8X079SS00C
Track Only		
1	Honda Civic 10G Type R track rear section	C32 - Track exhaust only
Touring Only		
1	Honda Civic 10G Type R HR9 rear section	C30 - Touring exhaust only



PARTS LIST



Inspect **ALL** parts prior to disassembly of vehicle; If damaged OR **MISSING**, please contact the place of purchase immediately.

Honda Civic Type R

QTY	Description	Part Number
1	Honda Civic 10G Type R 2.0L front pipe	C26
1	Honda Civic 10G Type R Dual Phase resonated section	D77
1	Honda Civic 10G Type R mid section	C29
4	3.00in ACCU-SEAL	TAS300
1	Honda Civic 10G triple tip outlet CTR/Si coupe	C35
3	114mm exhaust tip	61000078 (chrome) or 61000078-BLK (black)
3	Barrel hardware clamp	BHM8X079SS00C
Track Only		
1	Honda Civic 10G Type R track rear section	C32 - Track exhaust only
Touring Only		
1	Honda Civic 10G Type R HR9 rear section	C30 - Touring exhaust only





NOTE: Always refer to the manufacturer's service manual for precise torque specifications on all OEM fasteners.



CAUTION: The exhaust may be **VERY HOT** — allow adequate time for the system to cool down before disassembly. Severe burns and injury will occur if skin comes into contact with a hot exhaust system.

STEP 1

Remove the OEM front metal heat shield from vehicle, pointed out in **Figure 1**.

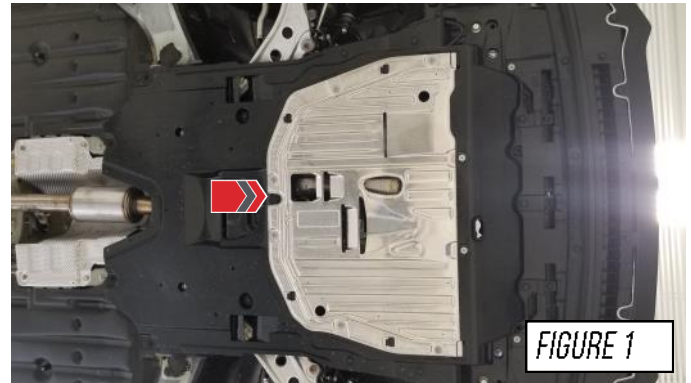

STEP 2

Remove the rear portion of the OEM plastic under body shield, shown in **Figure 2-1**. Carefully let it hang down, as shown in **Figure 2-2**. You may remove the whole panel but this is not required.

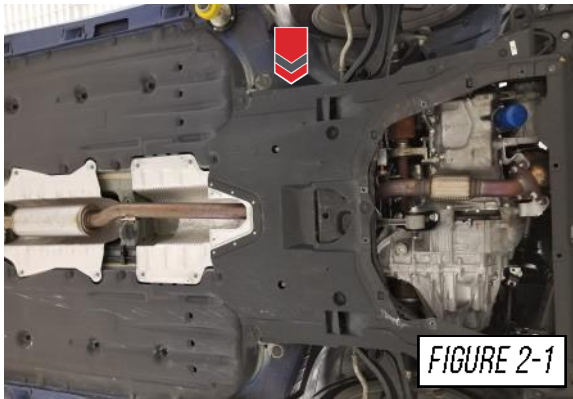

STEP 3

Remove the hardware and lower the OEM driver and passenger rear underbody panels covering the hangers, as shown in **Figure 3-1** and **Figure 3-2**.

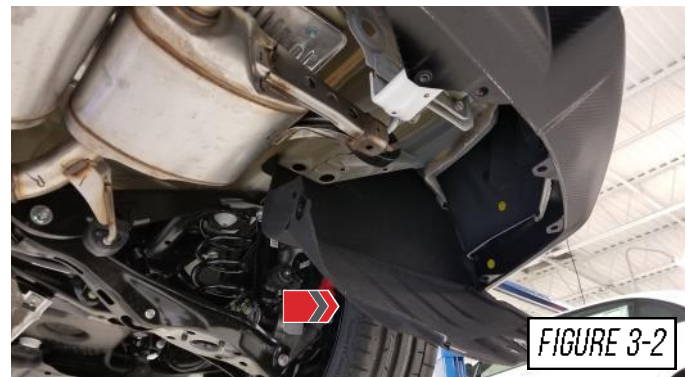

STEP 4

Remove the 3 bolts from the OEM exhaust flange that attaches the front pipe to the OEM downpipe, as shown in **Figure 4**.

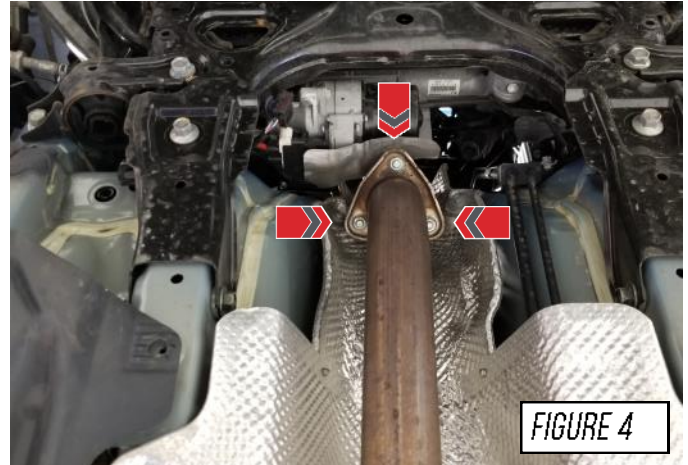

STEP 5

Remove the middle rubber exhaust hanger from the exhaust tube, as shown in **Figure 5**.



Note: The rubber mount must be reinstalled with the AWE exhaust in the same direction as when removed.

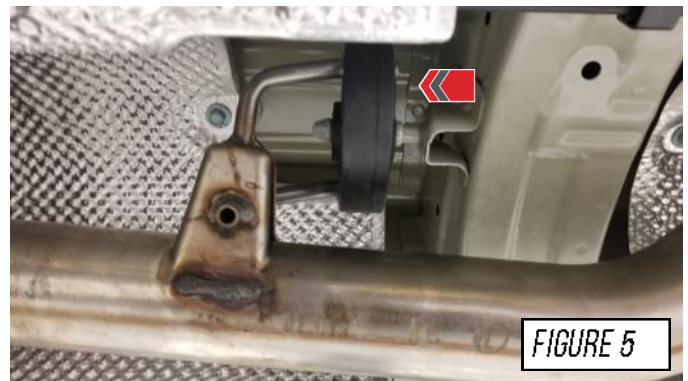

STEP 6



Support the rear section of the exhaust to prevent falling while removing the remainder of the hangers.

Remove the 2 rubber hangers toward the rear of the muffler section, shown in **Figure 6**.

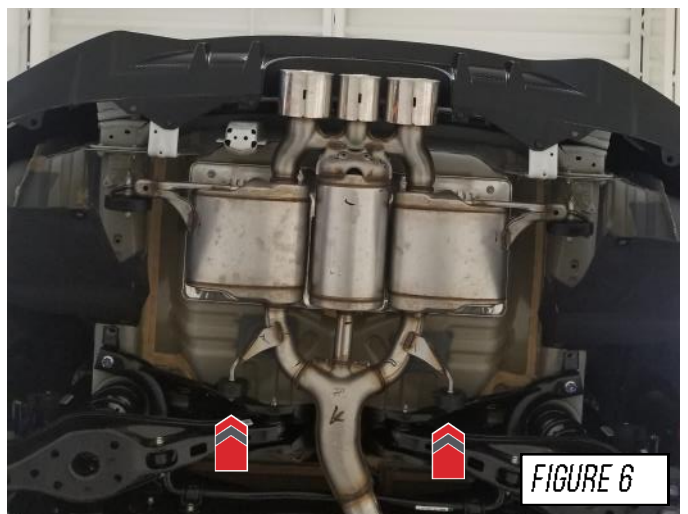

STEP 7

Remove the 2 remaining rubber exhaust hangers in the rear, as shown in **Figure 7-1** and **7-2**. At this point the exhaust may be removed.



Having a second person will make the removal easier and safer.

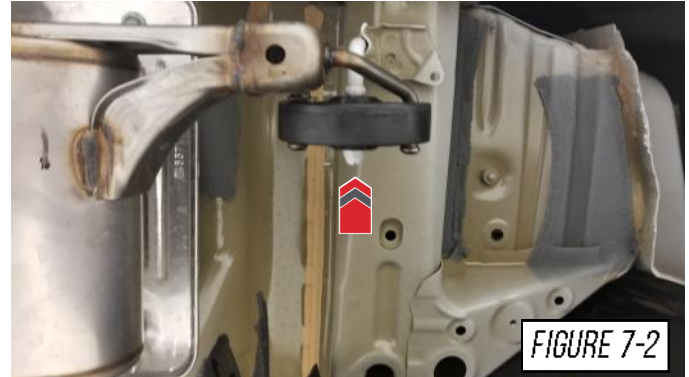

STEP 8

Now remove the rubber hanger for the front section of the exhaust, shown in **Figure 8**.

This hanger grommet can be completely removed from the car as it will not be needed for reinstalling the new AWE exhaust.

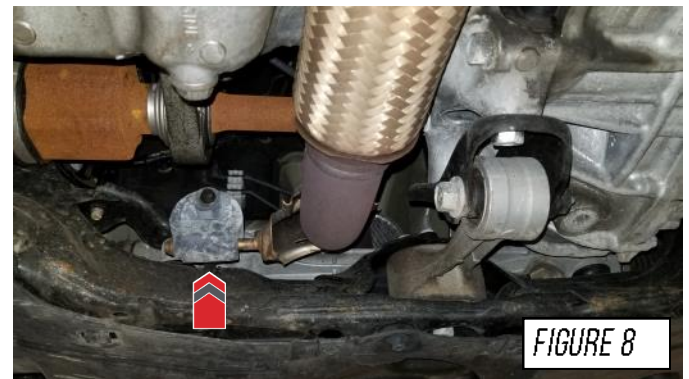

STEP 9

Remove the 3 bolts for the OEM exhaust flange to down pipe, shown in **Figure 9**.



Pre soak the 3 bolts with penetration oil to aid in the removal.

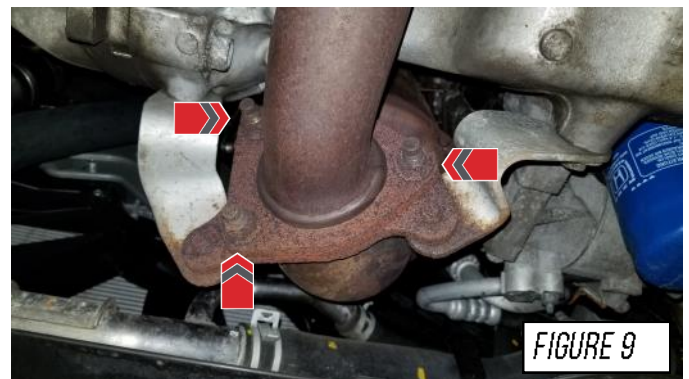

STEP 10

Remove the OEM front tunnel heat shield from the middle of the car, shown in **Figure 11-1**, to allow your AWE front pipe to be installed into the car.



This heat shield will be reinstalled after your new AWE front pipe is installed.

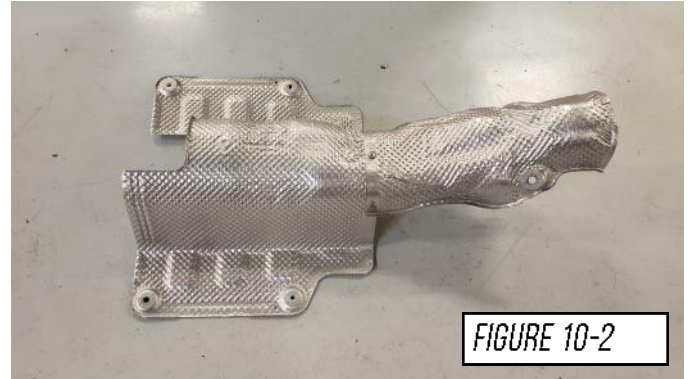

STEP 11

Remove the front pipe, shown in **Figure 11**.



Make sure to save the metal O-ring gasket from the front of the downpipe, this will be needed for installation of your new AWE exhaust.



STEP 12

The OEM downpipe surface must be clean and free of debris, shown in **Figure 12**, to allow an air tight seal with your new AWE exhaust.

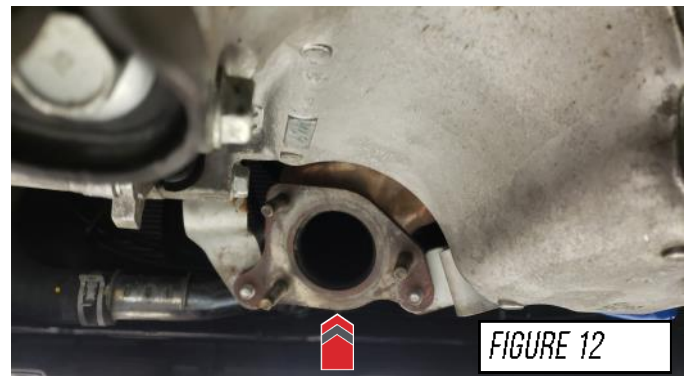

STEP 13

Remove the engine mount bolt, as shown in **Figure 13-1** and **Figure 13-2**. This will allow you to push the engine, with a pry bar, just a enough for fitment of the AWE front pipe (**Step 14**).



The engine will not move and there is no need to support the engine.

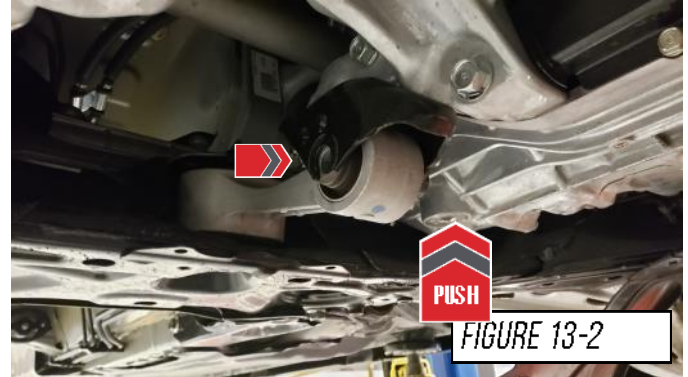
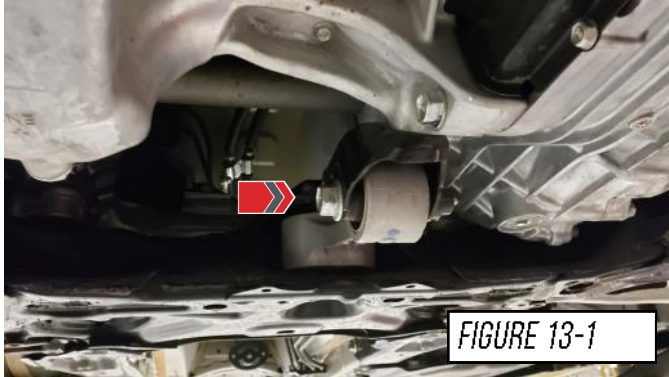

STEP 14

To began installing your AWE front pipe (**C26**.) first use a pry bar, pushing the engine (**Step 13**). This will provide you with the required clearance to insert the front pipe up and into the vehicle, as shown in **Figure 14-1** and **14-2**.



This installation must be completed from the front of the vehicle.

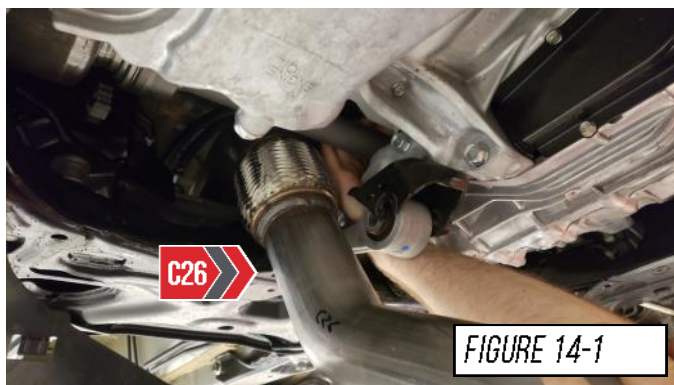

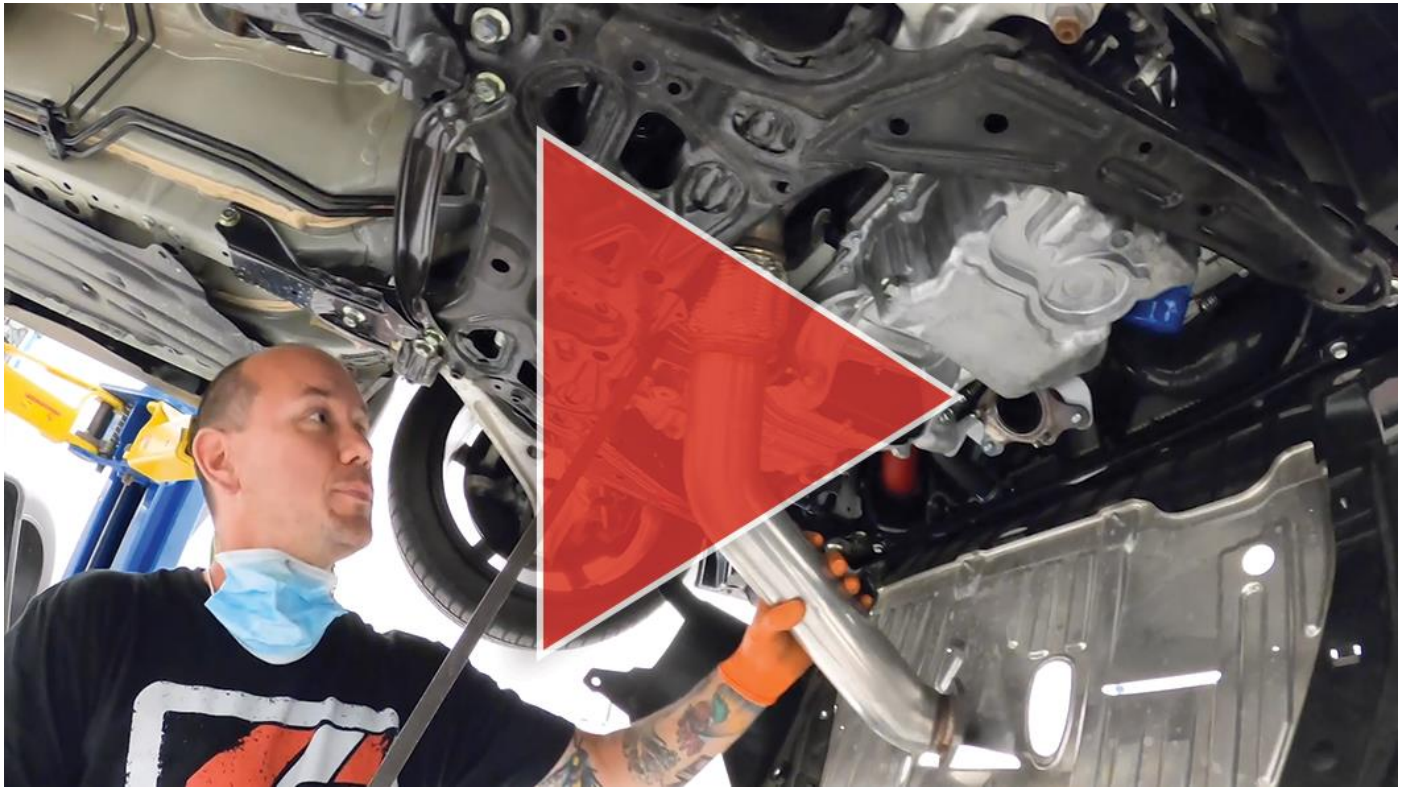

STEP 15

Reinstall the OEM motor mount bolt removed earlier, as shown in **Figure 15**.



Torque bolt to factory specifications



STEP 16

Install the OEM O-ring that was removed from the factory exhaust front pipe, as shown in **Figure 16**.

 The O-ring can be installed in either direction



STEP 17

Line up the 3 studs with your new AWE front pipe, shown in **Figure 17-1**. Install and secure factory nut removed earlier, shown in **Figure 17-2**.

 Torque nuts to factory specification.

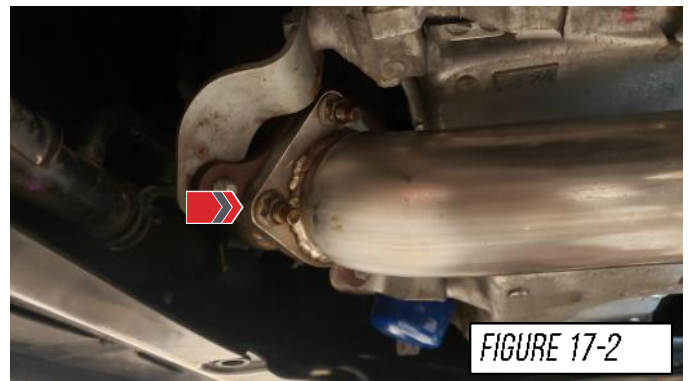
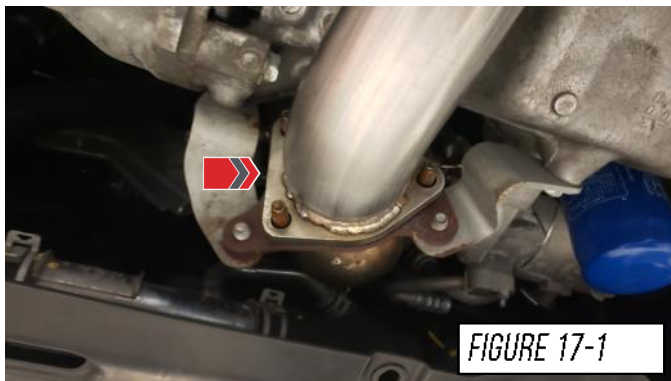

STEP 18

Reinstall the OEM metal heat shield that was removed earlier, as shown in **Figure 18-1**, using the same hardware, as shown in **Figure 18-2**.

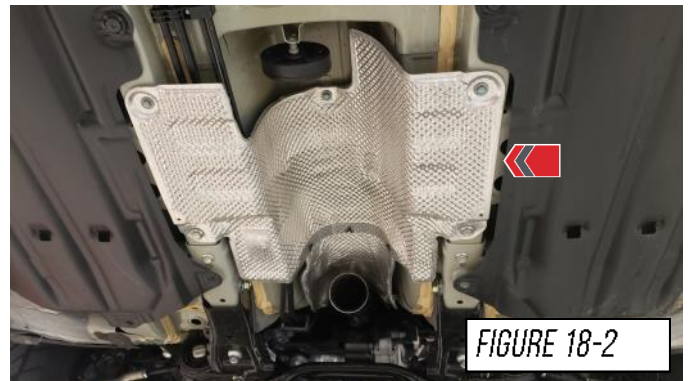

STEP 19

When installing the OEM rubber hanger grommet, ensure the orientation is the same as factory, as shown in **Figure 19**.

 The shape of the rubber hanger is different top to bottom.



STEP 20

Install your new AWE resonated section part number **C28***, with the supplied Accu-Seal clamp, shown in **Figure 20-1**.

 The Accu-Seal clamp bolt must face the driver side and down in order to access, as shown in **Figure 20-2**.

 *The AWE Dual Phase resonated section part number **D77** will be installed the same way as the AWE Resonated section part number **C28**.

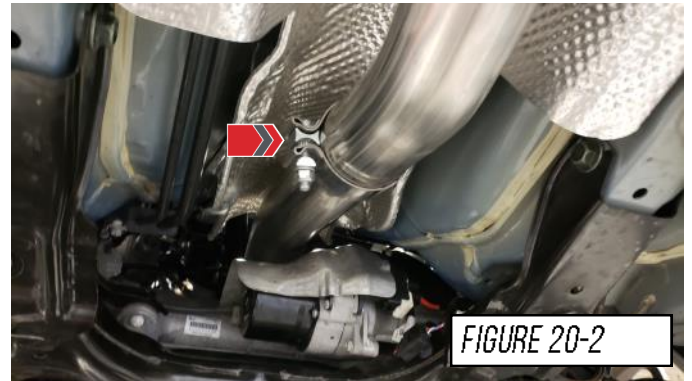
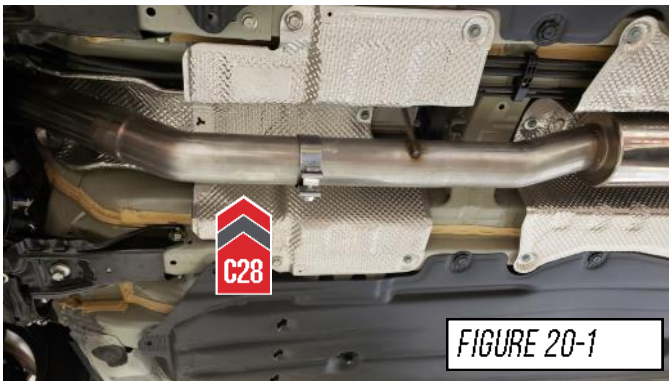

STEP 21

 Install your new AWE mid section, part **C29** with the supplied Accu-Seal clamps, as shown in **Figure 21**.

Use a pole jack to support the tube as there is no hangers.



STEP 22

When installing your AWE rear section you will need to use the appropriate exhaust hanger locations.

Track exhausts use hangers **A**.

Touring exhausts use hangers **A** and **B**.

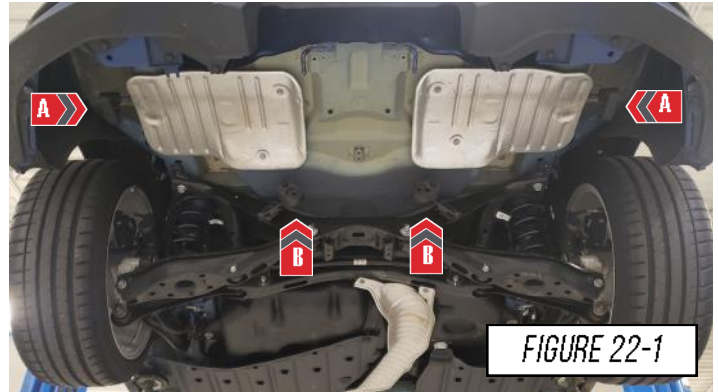

STEP 23

It is crucial to install each section and exhaust band clamp correctly to prevent loose joints, exhaust leaks between the tubing connections and rattles.

Arrow A in **Figure 23** shows the expanded pipe and the preinstalled exhaust clamp being brought up to the corresponding pipe.

Arrow B in **Figure 23** shows the overlapping pipe installed correctly over the corresponding pipe.

Arrow C in **Figure 23** shows the exhaust clamp being brought to the edge of the expanded pipe.



NOTES:

- **Do not** torque any exhaust clamp until the entire exhaust has been installed and adjusted.
- Torque specification is a **minimum** of 60 ft/lbs

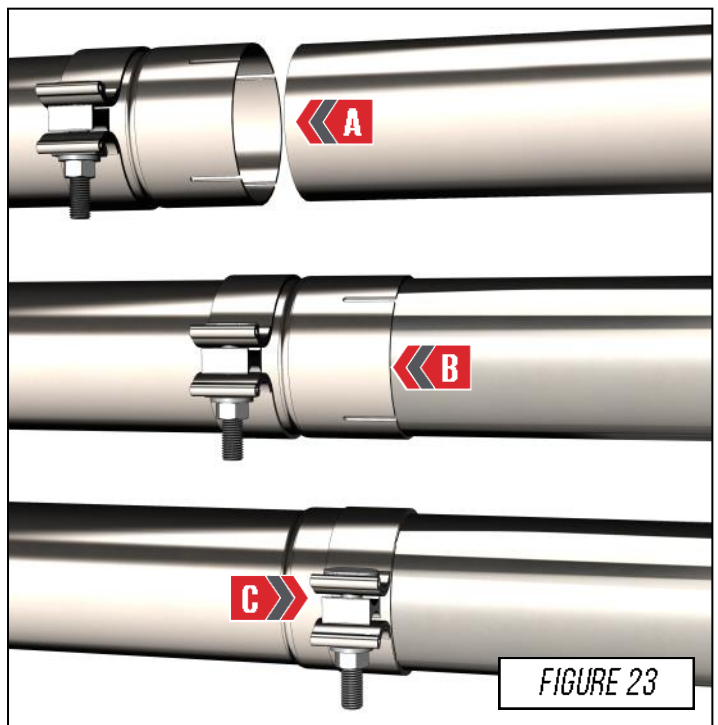

STEP 24

Next, install the tri-tip merge (**Part C35**) onto the exhaust system using one of the 3 inch exhaust clamps.

 **NOTE:** The tri-tip merge is directional. The slight angle of the tip section inlet should project upwards as shown in **Figure 24-2** and **Figure 24-3**.

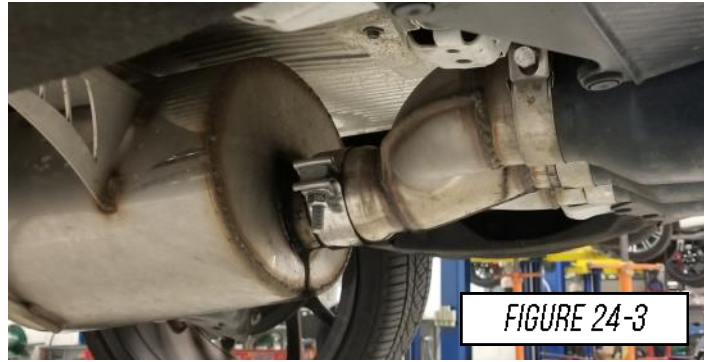
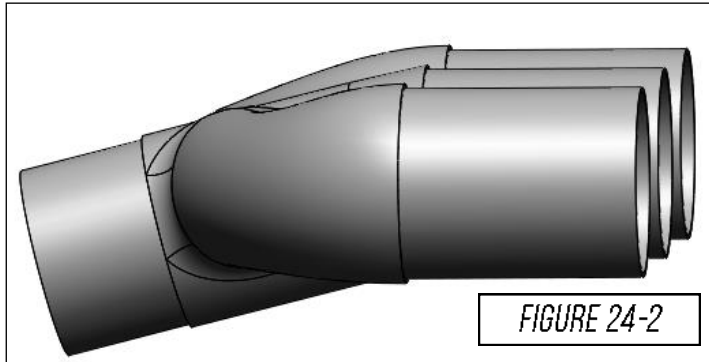

STEP 25

Reinstall the rear underbody panels, as shown in **Figure 28**.



STEP 26

Install 3 AWE tips onto the tip outlet section, as shown in **Figure 26**, with the t-bolt.

 Use anti-seize on tip clamp bolts.



STEP 27

To accomplish the best tip fitment, align the 3.0" tip clamp to cover *only* the slot, as shown by **Arrow A** in **Figure 27**.

The clamp should only be covering the section of the tip that has been slotted, as shown by **Arrow B** in **Figure 27**.

Torque the tip clamp to a **minimum** of 18 ft./lbs.



NOTES:

- It is recommended to apply anti-seize to the threads to prevent thread binding, shown by **Arrow C** in **Figure 27**.
- It is okay to have the clamp extend beyond the edge of the tip inlet.

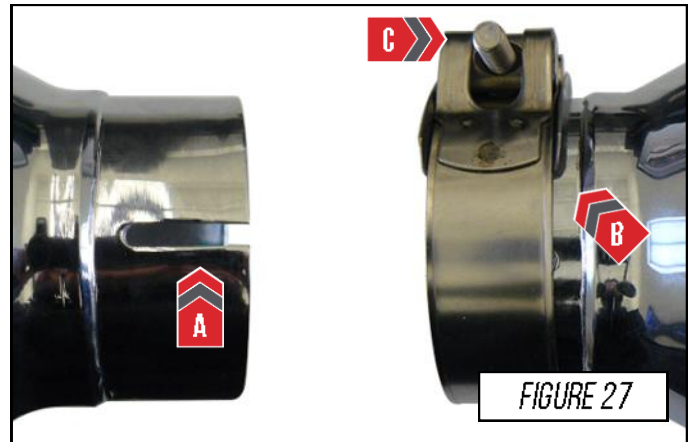

STEP 28

Reinstall the OEM plastic under body shield and heat shield, shown in **Figure 28**.

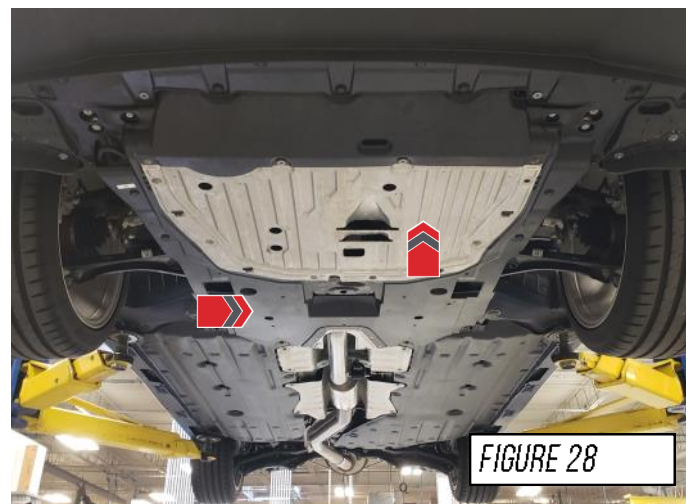

ENJOY!



TROUBLESHOOTING

Issue	Solution
Exhaust is not fitting correctly	Most fitment issues are due to improperly adjusted exhaust. This includes tip fitments and rattling due to chassis contact. Check out our fitment guide for more installation tips.
Wrong or missing parts	Double check the parts list for your system and compare them with what you received. Fill out our contact form, found below and let us know what parts you need.

CARE

Once installed properly, your AWE exhaust will provide years of trouble-free performance.

The exhaust volume and sound will settle with usage; 800-1000 miles is required to break-in new exhaust systems.

Also, please note that the rear **180Technology®** resonator has a small drain hole to allow condensation to escape. Water drops from this area are normal.

Periodic cleaning of exhaust tips is necessary to maintain proper finish, especially in areas prone to road salt and caustic deicing solutions. Use a mild soap and water solution or car wax to clean the finish. Avoid using abrasive polishes, as they can scratch the finish.

Any questions or comments,
please do not hesitate to contact us:

AWE
199 Precision Drive
Horsham, PA 19044
215-658-1670
[CONTACT FORM](#)

WARRANTY

Up-to-date warranty information is found [HERE](#).