

# VEHICLE APPLICATION PRODUCT GUIDE

## UNIVERSAL FIT PARTS

<< JDM / USDM / EDM >>

- TOYOTA
- NISSAN
- HONDA
- MAZDA
- MITSUBISHI
- SUZUKI
- SUBARU
- DAIHATSU
- ISUZU
- AMERICAN
- EUROPEAN

PROGRESSIVE EQUIPMENT®

**CUSCO**

- ▶ SUSPENSION
- ▶ SWAY BAR
- ▶ STRUT BAR
- ▶ PILLOWBALL MOUNT
- ▶ CLUTCH
- ▶ LIMITED SLIP DIFFERENTIAL
- ▶ ROLL CAGE
- ▶ COMPETITION PARTS
- ▶ ENGINE PARTS
- ▶ ADDITIONAL PARTS

# UNIVERSAL FIT PARTS

## PILLOW BALL UPPER MOUNT CAMBER ADJUST PILLOWBALL UPPER MOUNT

**\* FLAT MOUNTING PLATE : NO PRE-DRILLED HOLES**  
 Enables camber adjustment on suspension coilovers. Correct wheel alignment irregularities or setup the suspension to your specific race setting.

- Quick steering feedback and rigid feel
- 6mm thick Duralumin 2017S plates (8mm on some vehicles)
- Pillow nut & collar caters to various suspension systems
- Kit includes : Upper mount x 2, Pillow collar x 2, Pillow nut x 2

Mounting bolts (M8 x P1.25 x 30) x 8, Mounting bolts (M10 x P1.25 x 30) x 8

**00B 410 A (Camber Adjustable) : Mounting plate OD = 145 mm**  
**\$320 MSRP**

: Special order size are available  
 Mounting plate OD = 130 mm, 135 mm, 160 mm, 173 mm

**00B 410 A + (Specific size)**  
**\$360 MSRP**

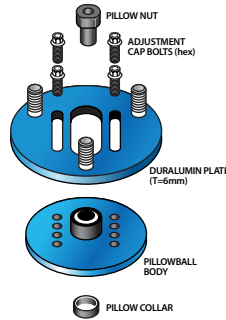

## FIXED PILLOWBALL UPPER MOUNT

**\* FLAT MOUNTING PLATE : NO PRE-DRILLED HOLES**  
 ■ Can be mounted directly on top of spring via inner sheet  
 ■ Quick steering feedback and rigid feel  
 ■ 10mm thick Duralumin 2017S plates  
 ■ Pillow nut & collar caters to various suspension systems

Special rally Gravel Spec avail with larger pillowball (MBWT18 & MBTW22)

**00B 411 A (Fixed Camber Adjustable) : Mounting plate OD = 145 mm**

**\$320 MSRP**

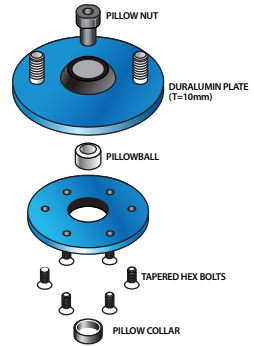

### Adjusting Camber

Sliding the plate inward produces negative camber.  
 Sliding the plate outward produces positive camber.

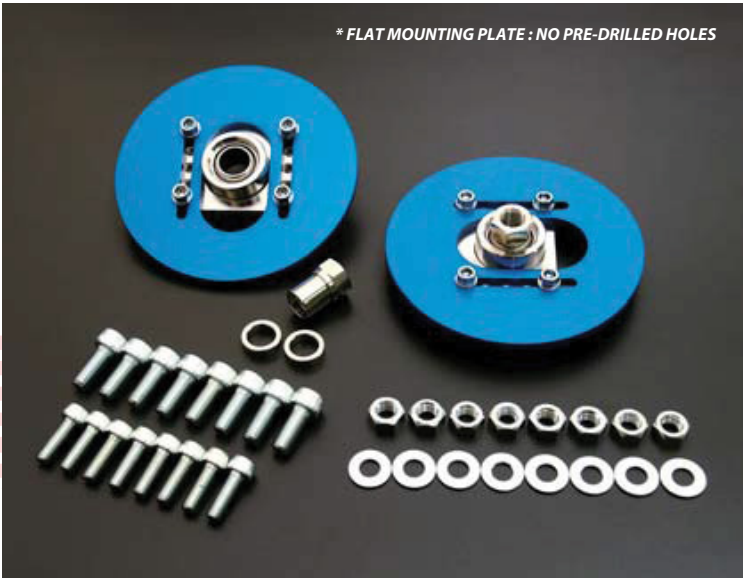
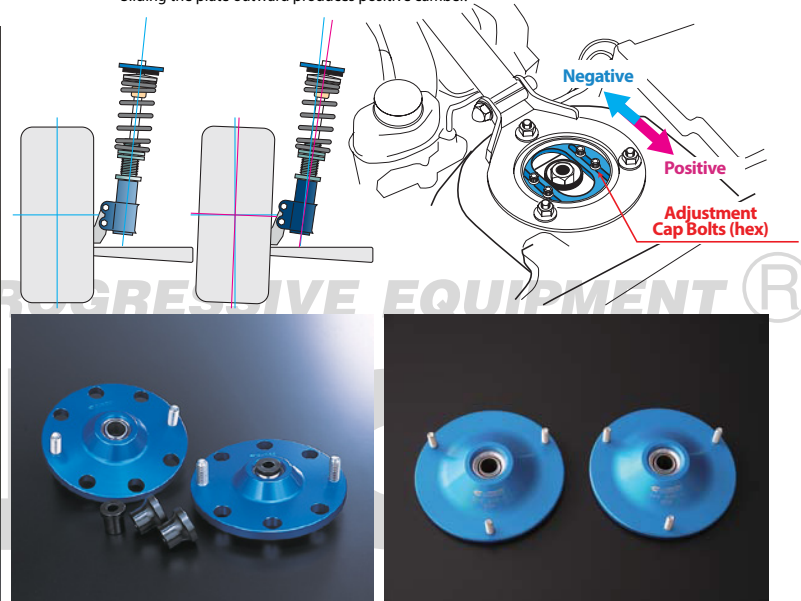

## HELPER SPRING

Helper spring constantly applies preload to the sprung assembly and is fully compressed at static ride height.

Part No: 065 063 0020 : \$40 (MSRP) / EACH

- ID 65mm Spring
- 2.0 kg/mm Rate
- 63 mm Length
- 21 mm Compressed Length

Part No: 073 105 0010 : \$40 (MSRP) / EACH

- ID 75 mm Spring
- 1.0 kg/mm Rate
- 105 mm Length
- 21 mm Compressed Length



## RIGID ALUMINUM SPRING SEAT

Replaces rubber spring seats for an improved linear and solid feel.

Part No: 00B S06 65A : \$14 (MSRP) / EACH

- 6 mm thickness
- For ID 65 spring



## CENTER SHEET

Center sheets keep the Helper springs aligned with the rest of suspension when the coilover is in motion.

Part No: 00B 601 061S : \$40 (MSRP) / EACH

- ID 65 mm to ID 65 mm Spring
- 2 mm Light weight steel type



### Standard Steel Type

Part No: 00B 665 01 : \$27 (MSRP) / EACH

- ID 73 mm to ID 73 mm Spring

Part No: 00B 665 02 : \$27 (MSRP) / EACH

- ID 73 mm to ID 63 mm Spring

Part No: 00B 665 03 : \$27 (MSRP) / EACH

- ID 63 mm to ID 63 mm Spring



## ALUMINUM SPRING UPPER SEAT

Universal fitment for several spring and shock rod size combination.

Part No: 00A 661 ~ : \$40 (MSRP) / EACH

- 8.0 mm height

Spring ID	Shock Rod OD	Part No.	Actual Hole Size
ID60	10mm OD shaft	00A 661 BH	10.5 mm ID
	12mm OD shaft	00A 661 BN	12.5 mm ID
	14mm OD shaft	00A 661 BT	15.1 mm ID
ID63	10mm OD shaft	00A 661 CH	10.5 mm ID
	12mm OD shaft	00A 661 CN	12.5 mm ID
	14mm OD shaft	00A 661 CT	15.1 mm ID
ID65	10mm OD shaft	00A 661 DH	10.5 mm ID
	12mm OD shaft	00A 661 DN	12.5 mm ID
	14mm OD shaft	00A 661 DT	15.1 mm ID
ID70 ~ 75	10mm OD shaft	00A 661 AH	10.5 mm ID
	12mm OD shaft	00A 661 AN	12.5 mm ID
	14mm OD shaft	00A 661 AT	15.1 mm ID



# UNIVERSAL FIT PARTS

## COILOVER SLEEVE

Weld on to the shock case to make coilover for Straight cut springs

- 2 pcs (Right & Left) set
- 110 mm long threaded part
- 50 mm ID Sleeve is 140 mm long threaded part
- 50 mm ID Sleeve is for Ohlins & Bilsteins C-Ring



Sleeve ID	Spring ID	Part No.	Price
ID 45.0 mm	60 ~ 63 mm ID	00B 650 A	\$134 MSRP
	65 mm ID	00B 630 A	\$134 MSRP
	70 ~ 75 mm ID	00B 640 A	\$134 MSRP
ID 50.8 mm	60 ~ 63 mm ID	00B 650 B	\$134 MSRP
	65 mm ID	00B 630 B	\$134 MSRP
	70 ~ 75 mm ID	00B 640 B	\$134 MSRP
ID 52.0 mm	65 mm ID	00B 630 C	\$134 MSRP
	70 ~ 75 mm ID	00B 640 C	\$134 MSRP
ID 54.0 mm	70 ~ 75 mm ID	00B 640 D	\$134 MSRP
	70 ~ 75 mm ID	00B 640 E	\$200 MSRP
ID 50.0 mm <i>for Ohlins &amp; Bilsteins C-Ring</i>	60 ~ 63 mm ID	00B 657 A	\$160 MSRP
	65 mm ID	00B 658 A	\$160 MSRP
	70 ~ 75 mm ID	00B 656 A	\$160 MSRP

## COILOVER SLEEVE for Stock / OE spring

- \$227 msrp : 2 pcs (Right & Left) set
- For Stock / OE style spring
- weld spring lower seat to the attachment
- 150 mm long threaded part

Sleeve ID	Part No.
50.8 mm ID	00A 626 A
54.0 mm ID	00A 626 B
56.0 mm ID	00A 626 C



## COILOVER SPRING

Individual spring is available from Rally to Circuit.

for Gravel Rally / Dirt Trial

Rate	Spring ID	Free Length	Stroke	Part No.	Price	Remarks
2.7 kgf/mm	65 mm	300 mm	210 mm	65G110 300 027	\$200 MSRP	Slight Barrel shape / Max OD 110mm
2.7 kgf/mm	65 mm	320 mm	215 mm	65G100 320 027	\$200 MSRP	Slight Barrel shape / Max OD 100mm
3.5 kgf/mm	65 mm	320 mm	203 mm	65G100 320 035	\$200 MSRP	Slight Barrel shape / Max OD 100mm
4.2 kgf/mm	65 mm	320 mm	192 mm	65G100 320 042	\$200 MSRP	Slight Barrel shape / Max OD 100mm
2.5 kgf/mm	73 mm	260 mm	190 mm	73G120 260 025	\$107 MSRP	Barrel shape / Max OD 120mm
2.9 kgf/mm	73 mm	270 mm	195 mm	73G120 270 029	\$107 MSRP	Barrel shape / Max OD 120mm
3.5 kgf/mm	73 mm	310 mm	195 mm	073 310 035	\$200 MSRP	
3.5 kgf/mm	73 mm	280 mm	180 mm	073 280 035	\$200 MSRP	

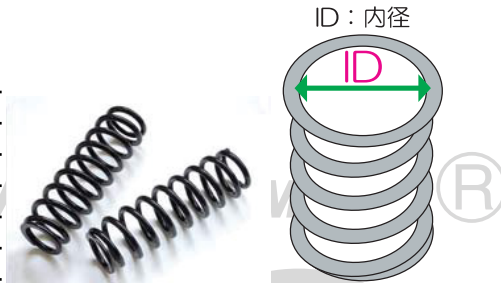

## Straight Cut Spring

Rate	Spring ID	Free Length	Stroke	Part No.	Price	Rate	Spring ID	Free Length	Stroke	Part No.	Price
20.0 kgf/mm	65 mm	135 mm	53 mm	065 135 20R	\$116 MSRP	3.0 kgf/mm	65 mm	200 mm	127 mm	065 200 03	\$80 MSRP
22.0 kgf/mm	65 mm	135 mm	53 mm	065 135 22R	\$116 MSRP	3.5 kgf/mm	65 mm	200 mm	130 mm	065 200 035	\$80 MSRP
24.0 kgf/mm	65 mm	135 mm	53 mm	065 135 24R	\$116 MSRP	4.0 kgf/mm	65 mm	200 mm	123 mm	065 200 04	\$80 MSRP
26.0 kgf/mm	65 mm	135 mm	53 mm	065 135 26R	\$116 MSRP	5.0 kgf/mm	65 mm	200 mm	120 mm	065 200 05	\$80 MSRP
7.0 kgf/mm	65 mm	150 mm	83 mm	065 150 07R	\$107 MSRP	6.0 kgf/mm	65 mm	200 mm	115 mm	065 200 06	\$80 MSRP
8.0 kgf/mm	65 mm	150 mm	79 mm	065 150 08R	\$107 MSRP	7.0 kgf/mm	65 mm	200 mm	110 mm	065 200 07	\$80 MSRP
9.0 kgf/mm	65 mm	150 mm	77 mm	065 150 09R	\$107 MSRP	8.0 kgf/mm	65 mm	200 mm	105 mm	065 200 08	\$80 MSRP
10.0 kgf/mm	65 mm	150 mm	73 mm	065 150 10R	\$116 MSRP	9.0 kgf/mm	65 mm	200 mm	105 mm	065 200 09	\$80 MSRP
11.0 kgf/mm	65 mm	150 mm	73 mm	065 150 11	\$94 MSRP	10.0 kgf/mm	65 mm	200 mm	101 mm	065 200 10	\$80 MSRP
12.0 kgf/mm	65 mm	150 mm	68 mm	065 150 12R	\$116 MSRP	11.0 kgf/mm	65 mm	200 mm	100 mm	065 200 11	\$94 MSRP
14.0 kgf/mm	65 mm	150 mm	68 mm	065 150 14R	\$116 MSRP	12.0 kgf/mm	65 mm	200 mm	97 mm	065 200 12	\$94 MSRP
16.0 kgf/mm	65 mm	150 mm	68 mm	065 150 16R	\$116 MSRP	14.0 kgf/mm	65 mm	200 mm	91 mm	065 200 14	\$94 MSRP
18.0 kgf/mm	65 mm	150 mm	64 mm	065 150 18R	\$116 MSRP	16.0 kgf/mm	65 mm	200 mm	88 mm	065 200 16	\$94 MSRP
						18.0 kgf/mm	65 mm	200 mm	85 mm	065 200 18	\$94 MSRP
						20.0 kgf/mm	65 mm	200 mm	84 mm	065 200 20	\$94 MSRP
4.0 kgf/mm	65 mm	180 mm	109 mm	065 180 04	\$80 MSRP	3.5 kgf/mm	65 mm	250 mm	154 mm	065 250 035	\$80 MSRP
5.0 kgf/mm	65 mm	180 mm	102 mm	065 180 05	\$80 MSRP	4.0 kgf/mm	65 mm	250 mm	152 mm	065 250 04	\$80 MSRP
6.0 kgf/mm	65 mm	180 mm	100 mm	065 180 06	\$80 MSRP	5.0 kgf/mm	65 mm	250 mm	144 mm	065 250 05	\$80 MSRP
7.0 kgf/mm	65 mm	180 mm	96 mm	065 180 07	\$80 MSRP	6.0 kgf/mm	65 mm	250 mm	138 mm	065 250 06	\$80 MSRP
8.0 kgf/mm	65 mm	180 mm	91 mm	065 180 08	\$80 MSRP	7.0 kgf/mm	65 mm	250 mm	135 mm	065 250 07	\$80 MSRP
9.0 kgf/mm	65 mm	180 mm	93 mm	065 180 09	\$80 MSRP	8.0 kgf/mm	65 mm	250 mm	129 mm	065 250 08	\$80 MSRP
10.0 kgf/mm	65 mm	180 mm	91 mm	065 180 10	\$80 MSRP	9.0 kgf/mm	65 mm	250 mm	123 mm	065 250 09	\$80 MSRP
11.0 kgf/mm	65 mm	180 mm	86 mm	065 180 11	\$94 MSRP	10.0 kgf/mm	65 mm	250 mm	123 mm	065 250 10	\$80 MSRP
12.0 kgf/mm	65 mm	180 mm	79 mm	065 180 12	\$94 MSRP	11.0 kgf/mm	65 mm	250 mm	123 mm	065 250 11	\$94 MSRP
14.0 kgf/mm	65 mm	180 mm	77 mm	065 180 14	\$94 MSRP						
16.0 kgf/mm	65 mm	180 mm	67 mm	065 180 16	\$94 MSRP						





# UNIVERSAL FIT PARTS

## Straight Cut Spring

Rate	Spring ID	Free Length	Stroke	Part No.	Price	Rate	Spring ID	Free Length	Stroke	Part No.	Price
3.0 kgf/mm	73 mm	200 mm	132 mm	073 200 03	\$80 MSRP	3.6 kgf/mm	73 mm	250 mm	158 mm	073 250 036	\$94 MSRP
4.0 kgf/mm	73 mm	200 mm	127 mm	073 200 04	\$80 MSRP	4.0 kgf/mm	73 mm	250 mm	156 mm	073 250 04	\$94 MSRP
5.0 kgf/mm	73 mm	200 mm	120 mm	073 200 05	\$80 MSRP	5.0 kgf/mm	73 mm	250 mm	151 mm	073 250 05	\$94 MSRP
6.0 kgf/mm	73 mm	200 mm	118 mm	073 200 06	\$80 MSRP	6.0 kgf/mm	73 mm	250 mm	146 mm	073 250 06	\$94 MSRP
7.0 kgf/mm	73 mm	200 mm	116 mm	073 200 07	\$80 MSRP	7.0 kgf/mm	73 mm	250 mm	140 mm	073 250 07	\$94 MSRP
8.0 kgf/mm	73 mm	200 mm	111 mm	073 200 08	\$80 MSRP	8.0 kgf/mm	73 mm	250 mm	135 mm	073 250 08	\$94 MSRP
9.0 kgf/mm	73 mm	200 mm	109 mm	073 200 09	\$80 MSRP						
10.0 kgf/mm	73 mm	200 mm	107 mm	073 200 10	\$80 MSRP	6.0 kgf/mm	73 mm	300 mm	159 mm	073 300 06	\$107 MSRP
11.0 kgf/mm	73 mm	200 mm	104 mm	073 200 11	\$94 MSRP						
12.0 kgf/mm	73 mm	200 mm	102 mm	073 200 12	\$94 MSRP						



## DAMPER ADJUSTMENT CABLE

Extend / relocate damper adjustment dial by flexible cable to convenient location.

- Sold as pair (2 pcs)
- Available in several length
- Easy bolt on installation

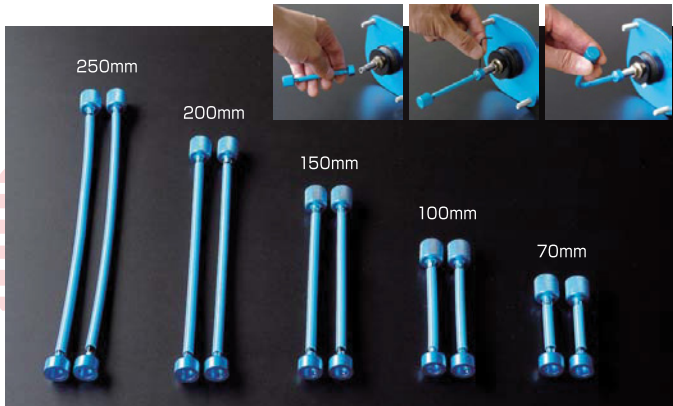

Cable Length	Part No.	Price
250 mm	00B 60N AJ25	\$54 MSRP
200 mm	00B 60N AJ20	\$54 MSRP
150 mm	00B 60N AJ15	\$54 MSRP
100 mm	00B 60N AJ10	\$54 MSRP
70 mm	00B 60N AJ07	\$54 MSRP
SPECIAL	943 60N AJ	\$104 MSRP

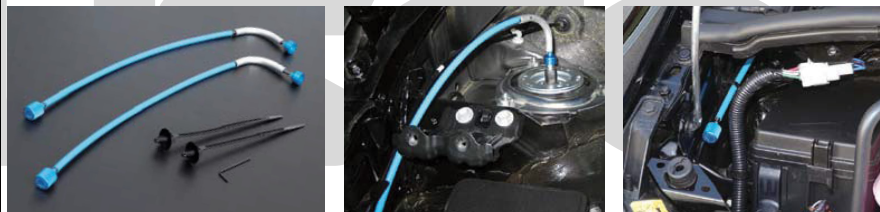

## Set the shocks from the driver seat



## 40 WAY ELECTRONIC DAMPER CONTROL e-Con2

- Street-A Kit : 00B 60J 1012
- Street ZERO-A Kit : 00B 60J 1014
- Touring A Kit : 00B 60J 1012
- \$634 (MSRP)

- Adjust 40way of front & rear shocks dampening
- Switch between vertical & horizontal display
- Record and save up to 4 shock setting profiles
- 7 different illumination colors to choose from
- G Sensor feature \$131 (Sold separately)



40 Way Adjust Step Motor



G Sensor

## COILOVER WRENCH : SWIVEL LOCKING TYPE

Patented swivel neck design wraps around and latches effectively.

Part No: 00A 670 SK7 : \$51 (MSRP) / EACH

- Patented design
- Extendable with 1/2 inch head



## COILOVER WRENCH

Required to adjust vehicle height on CUSCO coilover.

Part No: 00A 670 SK5 : \$20 (MSRP) / EACH

- Extendable with 1/2 inch head





## UNIVERSAL FIT PARTS

### AUTO HEADLIGHT LEVELER

Corrects headlight beams for lowered vehicles.

- Direct factory replacement 100% bolt on.
- Adjustable length via turnbuckle for any ride height.

The modern automobiles of today are equipped with an automatic headlight leveler that adjusts to the vehicle's ride height in real time. However when the vehicle suspension is altered (in most cases lowered), the headlights are pointed down towards the ground. This is due to the leveler sensor being stationed only in the rear of the car. In some cases, the ECU can reset to readjust the headlights according to its vehicle height, however there are parameter limitations for electronic sensors which will eventually require a mechanical approach to the solution.

**Stock ride height with stock auto levelizer**

Only rear height was changed. Stock Ride Height

**Due to only one sensor location in rear, head light beam goes down with low down vehicle.**

Low Down

**Cusco adjustable rod fix the issue by return to original sensor position.**

Low Down



00B 628 A		SHORT : Adjustable range 73 ~ 90 mm : \$67 MSRP
00B 628 B		LONG : Adjustable range 78 ~ 100 mm : \$67 MSRP
00B 628 C		SUPER SHORT : Adjustable range 55 ~ 59 mm : \$67 MSRP
00B 628 D		SUPER LONG : Adjustable range 93 ~ 115 mm : \$67 MSRP
00B 628 E		SEMI SHORT : Adjustable range 64 ~ 74 mm : \$67 MSRP
00B 628 FA		SHORT ROD + F-TYPE BRACKET : \$78 MSRP
00B 628 FB		LONG ROD + F-TYPE BRACKET : \$78 MSRP
00B 628 GA		SHORT ROD + G-TYPE BRACKET : \$78 MSRP
00B 628 GB		LONG ROD + G-TYPE BRACKET : \$78 MSRP
00B 628 IA		SHORT ROD + I-TYPE BRACKET : \$78 MSRP
00B 628 JA		SHORT ROD + J-TYPE BRACKET : \$78 MSRP
00B 628 KA		SHORT ROD + K-TYPE BRACKET : \$78 MSRP
00B 628 LA		SHORT ROD + L-TYPE BRACKET : \$78 MSRP
00B 628 MA		SHORT ROD + M-TYPE BRACKET : \$78 MSRP

### RACING METER

- Large 60 mm gauges
- High precision step motor technology for precise reading
- No control box necessary (only needs the gauge & sensor)
- Peak and warning function
- High quality bezel with LED technology
- Sensor and gauge holder included
- Night time auto dimming feature
- White LED lettering on top of black

#### Water & Oil Temp Meter

Part No: 00B 700 T : \$250 (MSRP) / EACH



#### Air Pressure Boost Meter

Part No: 00B 700 B : \$250 (MSRP) / EACH  
\* Turbo & Supercharger



#### Oil & Fuel Pressure Meter

Part No: 00B 700 P : \$300 (MSRP) / EACH







# UNIVERSAL FIT PARTS

## OIL COOLER KIT

Part No: 00B 013 A : \$960 (MSRP)

The Cusco Transmission & Rear Differential Oil Cooler Kit were developed to promote healthy gear life as well as preventing oil dissipation from extreme heat. This product is a must have for those who are running increased power output than factory more typically suited for high grip endurance.

Core : 9 Row  
 Core Dimension : 287 x 68 x 51 mm  
 Oil Pump Weight : 1.5kg  
 Oil Pump Size : ø 63 x 145mm  
 Oil Filter Size : ø 38 x 95mm



## OIL CATCH TANK

When routed inline with the crankcase PCV system, this oil catch can traps the harmful gasoline/oil mixture from re-entering the combustion chamber, resulting in a cleaner and more efficient burn.

Mount Type	Tank Volume	Tank Size	Part No.	Hose Size	Price
Street Vertical	0.3 L	OD : 80 mm x H : 78 mm	00B 009 SA	9.0 mm ID	\$131 (MSRP) <b>a.</b>
	0.3 L	OD : 80 mm x H : 78 mm	00B 009 SB	15.0 mm ID	\$131 (MSRP) <b>b.</b>
	0.6 L	OD : 80 mm x H : 154 mm	00B 009 HA	9.0 mm ID	\$131 (MSRP) <b>c.</b>
	0.6 L	OD : 80 mm x H : 154 mm	00B 009 HB	15.0 mm ID	\$131 (MSRP) <b>d.</b>
Competition Vertical	2.0 L	W150 x H205 x D80 x S32 mm	00A 010 A	9.0 mm ID	\$187 (MSRP) <b>e.</b>
	2.0 L	W150 x H205 x D80 x S32 mm	00A 010 B	15.0 mm ID	\$187 (MSRP) <b>f.</b>
	3.0 L	W150 x H230 x D100 x S32 mm	00A 011 A	9.0 (15.0) mm ID	\$200 (MSRP) <b>g.</b>
Oil / Air Separator Vertical	0.35 L	OD : 60 mm x H : 161 mm	00B 010 SA	15.0 mm ID (Only)	\$240 (MSRP) <b>h.</b>
	2.0 L	OD : 100 mm x H : 276 mm	00B 010 A	15.0 mm ID (Only)	\$240 (MSRP) <b>i.</b>
Street Horizontal	0.6 L	OD : 80 mm x H : 154 mm	00B 009 JA	9.0 mm ID	\$131 (MSRP) <b>j.</b>
	0.6 L	OD : 80 mm x H : 154 mm	00B 009 JB	15.0 mm ID	\$131 (MSRP) <b>k.</b>

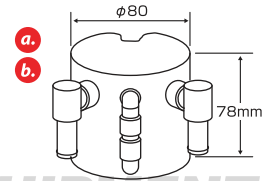

Tank Volume : 0.3 L

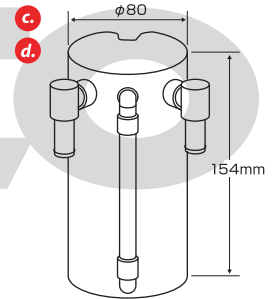

Tank Volume : 0.6 L

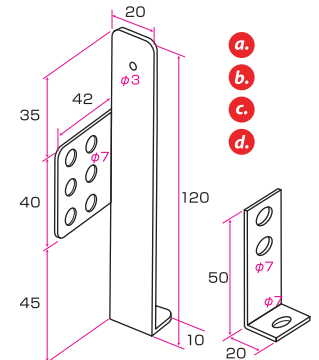

Brackets for Street Oil Catch Tank



Street Vertical - Tank Volume : 0.3 L



Street Vertical - Tank Volume : 0.6 L with 15 mm hose kit



Street Vertical - Tank Volume : 0.6 L with 9 mm hose kit



Competition Vertical - Tank Volume : 2.0 L

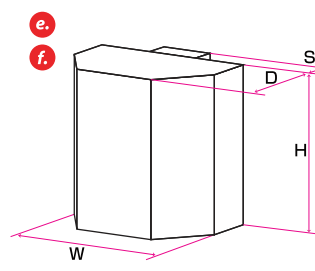

Separator Type : S-Size Tank Volume : 0.35 L



Separator Type : L-Size Tank Volume : 2.0 L



Tank Volume : 0.6 L : Side Mount Type



## UNIVERSAL FIT PARTS

### OIL CATCH TANK : OPTION PARTS

#### Extra hose kit

- Part No: 00B 009 A09 : \$35 (MSRP)
- 9.0 mm hose
  - 1 m length
- Part No: 00B 009 A15 : \$40 (MSRP)
- 15.0 mm hose
  - 1 m length



#### Hose Conversion Kit

- Part No: 00B 009 06 : \$31 (MSRP)
- Convert hose ID from 9 mm to 15 mm
  - ID9mm x 0.1 m length hose included



### POWER STEERING FLUID

#### APRC SPEC

- Part No: 010 003 P01A : \$83 (MSRP)
- Special blended with FM material
  - Competition use for Rally / Endurance race
  - 1L per can



#### STREET / SPORTS SPEC

- Part No: 010 003 P01S : \$51 (MSRP)
- High pressure resistant material concluded
  - Street and Circuit use
  - 1L per can



### LIMITED SLIP DIFFERENTIAL OIL

- Hydride purified base oil contained.
- Keeps its good performance against the heat after long-term use.
- For all mechanical LSD.
- Developed by CUSCO, the most familiarized company with LSD.
- Minimize the noise and vibration, and maximize the Performance.

- Hydride purified base oil contained.
- Very purified base oil provides the higher performance against heat.
- With the specially developed Friction Modifier, the Oil minimizes the chattering noise and wearing.
- Maximize the Life of the LSD.

#### API/GL5 SAE / 80W - 140

Part No: 010 001 R01 : \$43 (MSRP) / 1L per can

For rear LSD which is exposed by high load and heat with high performance engine, tire and suspension. Use for 4WD rear LSD & FR rear LSD. Also good for use in High temperature region and Hot Summer. For all mechanical LSD.

#### API/GL5 SAE / 80W - 90

Part No: 010 001 L01 : \$32 (MSRP) / 1L per can

Good for use with the Transmission of the FWD or AWD vehicles with LSD. Multi-grade oil performs even under extremely high/low temperature. Good for all mechanical LSD, from daily use to competition use.

#### API/GL4 SAE / 75W - 85

Part No: 010 002 M01 : \$32 (MSRP) / 1L per can

Lubricates both LSD & Transmission Hydride purified base oil contained. With its high quality base oil, Friction Modifier performs its best to make the synchronizer gear work the best. And surely lubricates under any situation. Friction Modifier saves the synchronizer gear being worn out during sport driving situation, and makes the shift feelings much better. As its Friction Modifier performs to the LSD, the OIL can be used for the FWD vehicles with LSD in its Transmission. It helps to the life of both synchronizer gear and LSD performance. 75W-85 oil assures you an easy shift work even under the cold temperature. Very purified base oil provides the higher performance against heat. No more fear with soft ATF or Engine oil for easier shift work!! Here is the solution.



### HIGH PRESSURE RADIATOR CAP

#### A - TYPE

- Part No: 00B 050 A13 : \$34 (MSRP)
- Protects against over heating
  - Promotes efficient coolant flow
  - Rated at 2.3 kg / cm<sup>2</sup>



#### B - TYPE

- Part No: 00B 050 B13 : \$34 (MSRP)
- Protects against over heating
  - Promotes efficient coolant flow
  - Rated at 2.3 kg / cm<sup>2</sup>







# UNIVERSAL FIT PARTS

## SPORTS OIL FILTER

Features a high powered magnet and ultra fine paper + mesh filter, effective for virtually any condition.

### A - TYPE

Part No: 00B 001 A : \$34 (MSRP)  
 ● ID 65 mm x H 65 mm  
 ● M20 - P1.5

### B - TYPE

Part No: 00B 001 B : \$34 (MSRP)  
 ● ID 65 mm x H 65 mm  
 ● 3/4 - 16 UNF

### C - TYPE

Part No: 00B 001 C : \$34 (MSRP)  
 ● ID 68 mm x H 65 mm  
 ● M20 - P1.5

### D - TYPE

Part No: 00B 001 D : \$34 (MSRP)  
 ● ID 76 mm x H 87 mm  
 ● 3/4 - 16 UNF

### E - TYPE

Part No: 00B 001 E : \$34 (MSRP)  
 ● ID 80 mm x H 70 mm  
 ● M20 - P1.5

### F - TYPE

Part No: 00B 001 F : \$34 (MSRP)  
 ● ID 80 mm x H 70 mm  
 ● 3/4 - 16 UNF



High efficient filter paper surely catch fine dust and contaminants.  
 This mesh filter protect the filter paper from changing the shape or damage even under extreme condition.  
 High magnetic force of high power magnet remove iron powders and protect the engine.

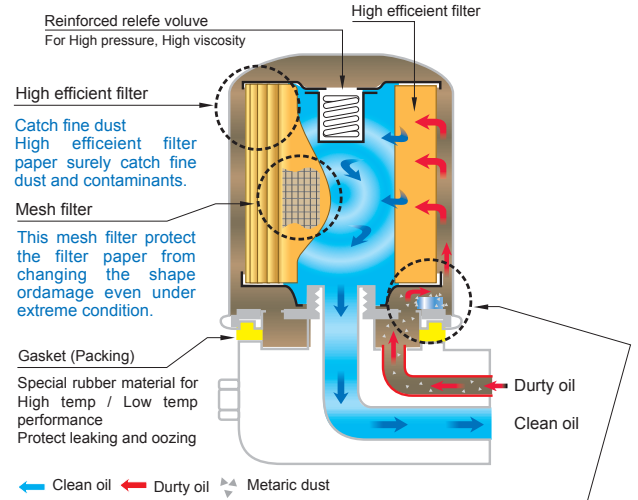
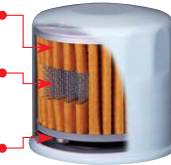

## HIGH MAGNETIC FORCE EFFECTIVENESS

High magnetic force of high power magnet remove iron powders and protect the engine.  
 High power magnet

## NEODYMIUM MAGNET DRAIN BOLT

Using a powerful 4500 Gauss Neodymium magnet, Cusco Aluminum Drain Bolt will capture metallic pollutants and microscopic particles that reside in motor oils, even those which may not be captured by oil filters. The A7075 Duralumin alloy drain plug body material is a standard in the aerospace industry, being one of the lightest and most durable, and comes integrated with an aluminum gasket ring as well.

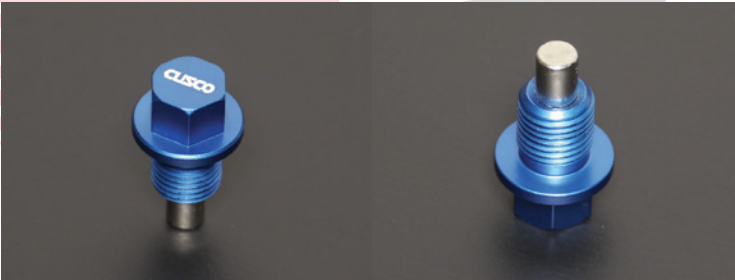

**TOYOTA / NISSAN**  
 Part No: 00B 001 ND01 : \$24 (MSRP)  
 ● M12 X P1.25

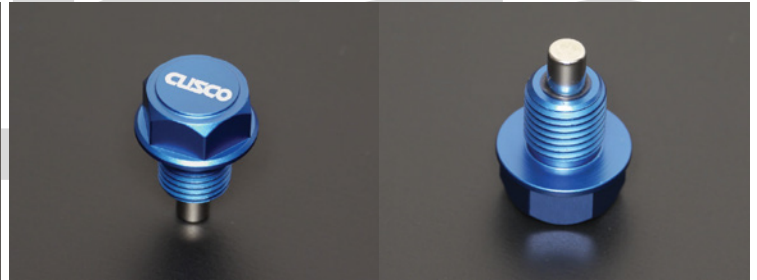

**HONDA / MAZDA / MITSUBISHI / SUZUKI**  
 Part No: 00B 001 ND02 : \$24 (MSRP)  
 ● M14 X P1.5

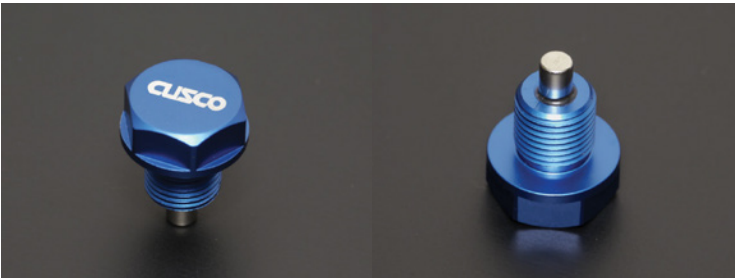

**FRS / BRZ / 86 / KOUKI**  
 Part No: 00B 001 ND03 : \$24 (MSRP)  
 ● M16 X P1.5

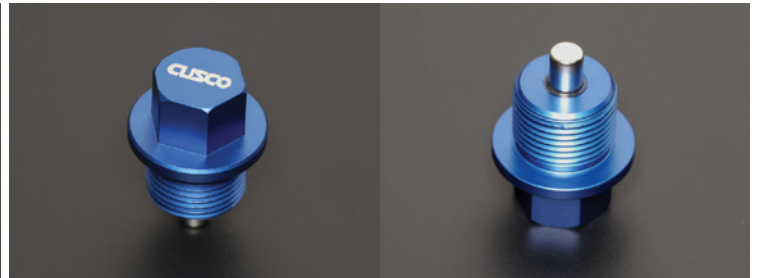

**SUBARU**  
 Part No: 00B 001 ND04 : \$24 (MSRP)  
 ● M20 X P1.5







# UNIVERSAL FIT PARTS

## BATTERY BRACKET

Add some Cusco blue to your engine bay by installing one of these battery tie downs! Three sizes are available for various vehicle applications.

### A - TYPE

- Part No: 00B 745 A : \$78 (MSRP)  
 ● Battery ID code : B  
 ● 129 mm width

### B - TYPE

- Part No: 00B 745 B : \$78 (MSRP)  
 ● Battery ID code : D  
 ● 173 mm width

### C - TYPE

- Part No: 00B 745 C : \$78 (MSRP)  
 ● Battery ID code : B  
 ● 129 mm width

### D - TYPE

- Part No: 00B 745 D : \$78 (MSRP)  
 ● Battery ID code : D  
 ● 129 mm width

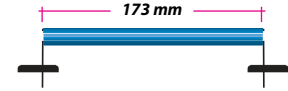
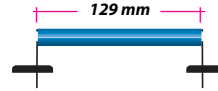
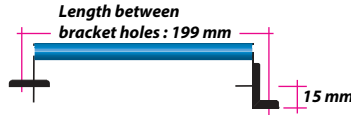
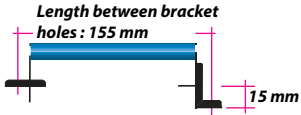

### Note JIS Battery Identification

**55D23L**

- Positive Terminal Location : L = Left
- Length : Long side : 23 = 23 cm
- Class : Short side
- Battery Capacity

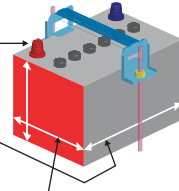

Class	Width	Height	Terminal	Bracket
B	129 mm (127 mm)	203 mm	Small	A or C Type
D	173 mm	204 mm	Large	B or D Type



## IGNITION CAPACITOR

Improves engine response from low to high RPM range by supplying the ignition coil with stabilized power. Maximizes efficiency and voltage resulting in an increased torque feel as well as full power to all electrically powered components.

- Part No: 965 726 A : \$214 (MSRP)  
 ● Vehicle specific harness sold separately



## PROGRESSIVE EQUIPMENT <sup>®</sup>

## UNIVERSAL HEAT SHEILD

Custom fit to any application.

- Part No: 00B 007 A : \$87 (MSRP)  
 ● Aluminum  
 ● 1000 mm x 300 mm

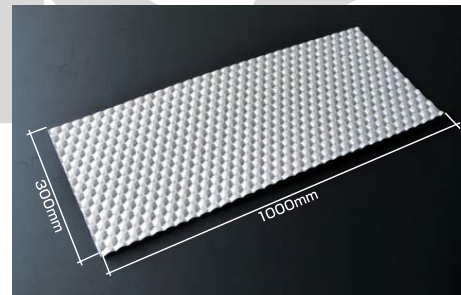

## EXHAUST HANGER

Maximum durability to support factory and OEM exhaust systems for vehicles in motor sports or spirited driving.

### B - Type

- Part No: A160 RM002B : \$12 (MSRP) / EACH  
 ● ID 11 mm x 40 mm  
 ● 26 mm thickness

### B

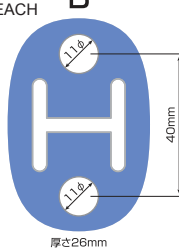

### C - Type

- Part No: A160 RM003B : \$12 (MSRP) / EACH  
 ● ID 9 mm x 40 mm  
 ● 23 mm thickness

### C

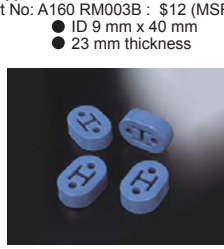

### D - Type

- Part No: A160 RM004B : \$12 (MSRP) / EACH  
 ● ID 15 mm x 35 mm  
 ● 25 mm thickness

### D

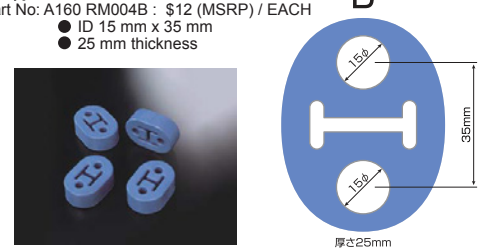

## OIL CATCH TANK : OPTION PARTS

A simple and elegant shift knob from Cusco. Made of Duracon (Polyacetate) that is lightweight and finished smooth. The shift pattern is impressed onto the knob showing a 5 or 6 speed shift pattern.

### Toyota / Subaru

- Part No: 00B 760 1WW : \$40 (MSRP)  
 ● M 12 x 1.25  
 ● White  
 ● OD : 40 mm

### Mitsubishi / Nissan / Mazda

- Part No: 00B 760 3WW : \$40 (MSRP)  
 ● M 10 x 1.25  
 ● White  
 ● OD : 40 mm

### Honda

- Part No: 00B 760 4WW : \$40 (MSRP)  
 ● M 10 x 1.5  
 ● White  
 ● OD : 40 mm





## UNIVERSAL FIT PARTS

### SPINTURN KNOB

This universal handbrake knob is made from aluminum and finished in silver, red, and blue. It replaces the factory handbrake knob and allows for free action of the handbrake.

#### TOYOTA / MITSUBISHI / MAZDA

Part No: 00B 014 AR: \$27 (MSRP)

- Red

Part No: 00B 014 AL: \$27 (MSRP)

- Blue

Part No: 00B 014 AA: \$27 (MSRP)

- Silver

\* Mazda : only for NA, NB, ND, & FC3S

#### NISSAN

Part No: 220 014 AR: \$27 (MSRP)

- Red

Part No: 220 014 AL: \$27 (MSRP)

- Blue

Part No: 220 014 AA: \$27 (MSRP)

- Silver

\* only for S13, S14, & RS13

\* need modify on side lever

#### SUBARU

Part No: 692 014 AR: \$27 (MSRP)

- Red

Part No: 692 014 AL: \$27 (MSRP)

- Blue

Part No: 692 014 AA: \$27 (MSRP)

- Silver

\* include Toyota ZN6



\* except Toyota MR2(SW20), Supra(70), IS300(SXE10), JZX100, and Mazda RX7(FD3S)

### PUSH STARTER RING

Part No: 965 730 G : \$24 (MSRP)

- Billet Aluminum with Blue Alumite finish
- OD : 47 mm / ID : 33 mm



### LEVEL GAUGE STOPPER

Part No: 965 730 E: \$160 (MSRP)

- Billet Aluminum with Blue Alumite finish
- It will not work with some model.

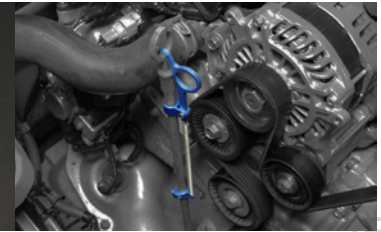
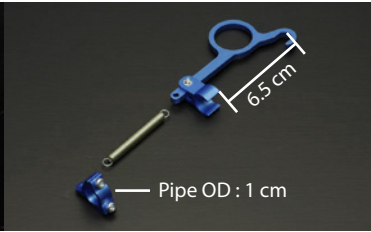

### SHORT ANTENNA

Eliminate factory elongated antenna and replace it with CUSCO version.

Part No: 00B 809 BB : \$34 (MSRP)

- BLACK
- Screw : M6 x P 0.8
- 5 mm & 6 mm adaptor & 8 mm spacer included

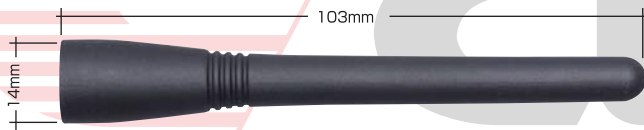

PROGRESSIVE

\* not for EVO X



### AERO-CATCH TYPE HOODPIN SET

The Aero-Catch type hood pin set sits flush with the vehicle body panel while serving as a secure hood pin.

#### Black - No Key

Part No: A574 AC BKF : \$214 (MSRP)

#### Black - With Key

Part No: A574 AC BKKF : \$240 (MSRP)

#### Carbon Style - No Key

Part No: A574 AC CBF : \$267 (MSRP)

#### Carbon Style - With Key

Part No: A574 AC CBKF : \$294 (MSRP)



### HOOD PIN / SPRING TRUNK HOOK

These are used for FRP / Carbon fiber body parts to give added insurance on top of the factory latch system and are required for regulations.

#### Hood Pin With Key & Lock

Part No: A517 C402 : \$80 (MSRP)

#### Spring Trunk Hook

Part No: 00B 818 A : \$34 (MSRP)

#### Aluminum Hood Pin

Part No: 00B 817 A : \$51 (MSRP)

#### Blue Aluminum Hood Pin

Part No: 00B 817 AL : \$54 (MSRP)

#### Black Aluminum Hood Pin

Part No: 00B 817 AB : \$54 (MSRP)



### LAP BEACON HOLDER

This lap beacon holder makes adding a lap beacon when you are at the track or just before competition a snap.

Part No: 00B 061 A : \$40 (MSRP)

- Clear polycarbonate plastic
- Compatible with TranX Pro system (AMB)







## UNIVERSAL FIT PARTS

### STEEL TOW HOOK

Add to your vehicle that sees competition, track support will appreciate it, and so will your vehicle.

#### Universal Tow Hook

Part No: 00A 016 AJ : \$107 (MSRP)  
 ● Racing Orange  
 ● Front & Rear 2 pcs set



#### Under Guard Tow Hook

Part No: 00A 016 AD : \$34 (MSRP)  
 ● Racing Orange  
 ● Sold as 1 pc



### TOW STRAP

Racing Tow Strap - 3,500 kgf Capacity, 310 mm Length, 50 mm Width (w/o Bracket), Hole size on bracket : 16 mm hole / 3 mm thick plate, Steel

Part No: 00B CTS RD : \$47 (MSRP)  
 ● Red  
 ● Sold as 1 pc



Part No: 00B CTS BL : \$47 (MSRP)  
 ● Blue  
 ● Sold as 1 pc



### FOLDING TOW HOOK

Made from strong steel and designed to bolt-on. The swivel tow hook can be folded 90 degrees when not in use, which will minimize its protrusion from the vehicle. Please check for available shaft size / length and thread pitch.

#### Price : \$131 (MSRP) / each

- 100 % Bolt-On
- Red Swivel Loop
- Hardened Steel
- JAF (Japanese Automobile Federation) compliant



### QUICK RELEASE LEVER

Enables quick removal of the strut bar center shaft without any hand tools. Replace strut bar nut & bolt set for OS, ALC, & HBD type.

Part No: 00B 540 C : \$54 (MSRP)  
 ● 2 pcs per set



### ROLLCAGE OPTIONAL PARTS

Add performance to your rollcage.

#### Rollcage Pad : 5.5 m

Part No: 00D 270 PB : \$87 (MSRP)  
 ● Black  
 ● OD : 40 mm pipe

#### Rollcage Pad : 1.2 m

Part No: 00D 270 PB12 : \$20 (MSRP)  
 ● Black  
 ● OD : 40 mm pipe



#### Seamless Tape : Black

Part No: 00D 251 AB : \$34 (MSRP)  
 ● 30 m length  
 ● 19 mm width



#### FIA Rollcage Pad

Part No: A461 PAD FIA 38 : \$80 (MSRP)  
 ● Black  
 ● 90 cm length  
 ● OD : 38 mm pipe  
 ● Embossed FIA Homologation No.  
 ● EAFSD3 Form

Part No: A461 PAD FIA 45 : \$80 (MSRP)

- Black
- 90 cm length
- OD : 45 mm pipe
- Embossed FIA Homologation No.
- EAFSD3 Form

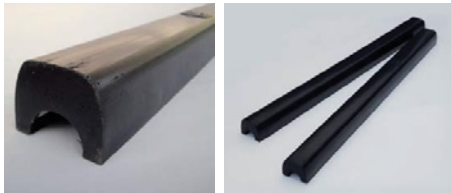

#### One Touch Rollcage Pad

Part No: 00D 275 PB : \$100 (MSRP)  
 ● 5.5 m length  
 ● Black



#### Rollcage Sun Visor

Part No: A461 RSUN2 : \$111 (MSRP)  
 ● Black anodized aluminum clip  
 ● Matt black finish  
 ● 2.0 mm thick Polycarbonate plate  
 ● 2 pcs in kit

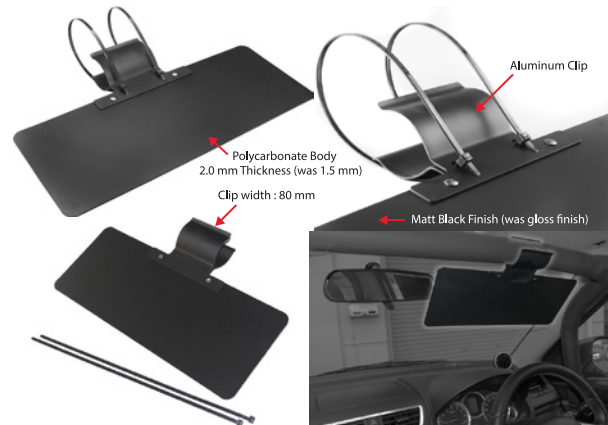





# UNIVERSAL FIT PARTS

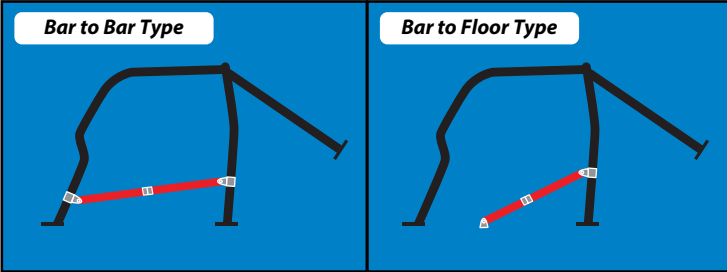

## ADD ON BAR

Connect 2 point on 40 mm OD rollcage. Center Turn-Buckle Adjustable System. Available 3 length in Steel, Aluminum, and Carbon Fiber.

### Steel : Bar to Bar Type

- Part No: 00D 270 AT10 : \$214 (MSRP) / each  
● 930 mm ~ 1020 mm
- Part No: 00D 270 AT11 : \$214 (MSRP) / each  
● 1030 mm ~ 1120 mm
- Part No: 00D 270 AT12 : \$214 (MSRP) / each  
● 1130 mm ~ 1220 mm
- Part No: 00D 270 AT13 : \$214 (MSRP) / each  
● 1230 mm ~ 1320 mm

### Steel : Bar to Floor Type

- Part No: 00D 270 FA : \$214 (MSRP) / each  
● 930 mm ~ 1020 mm
- Part No: 00D 270 FB : \$214 (MSRP) / each  
● 1030 mm ~ 1120 mm
- Part No: 00D 270 FC : \$214 (MSRP) / each  
● 1130 mm ~ 1220 mm

### Aluminum : Bar to Bar Type

- Part No: 00D 270 AT10A : \$240 (MSRP) / each  
● 930 mm ~ 1020 mm
- Part No: 00D 270 AT11A : \$240 (MSRP) / each  
● 1030 mm ~ 1120 mm
- Part No: 00D 270 AT12A : \$240 (MSRP) / each  
● 1130 mm ~ 1220 mm
- Part No: 00D 270 AT13A : \$240 (MSRP) / each  
● 1230 mm ~ 1320 mm

### Aluminum : Bar to Floor Type

- Part No: 00D 270 FAA : \$240 (MSRP) / each  
● 930 mm ~ 1020 mm
- Part No: 00D 270 FBA : \$240 (MSRP) / each  
● 1030 mm ~ 1120 mm
- Part No: 00D 270 FCA : \$240 (MSRP) / each  
● 1130 mm ~ 1220 mm

### Carbon Fiber : Bar to Bar Type

- Part No: 00D 270 AT10C : \$320 (MSRP) / each  
● 930 mm ~ 1020 mm
- Part No: 00D 270 AT11C : \$320 (MSRP) / each  
● 1030 mm ~ 1120 mm
- Part No: 00D 270 AT12C : \$320 (MSRP) / each  
● 1130 mm ~ 1220 mm
- Part No: 00D 270 AT13C : \$320 (MSRP) / each  
● 1230 mm ~ 1320 mm

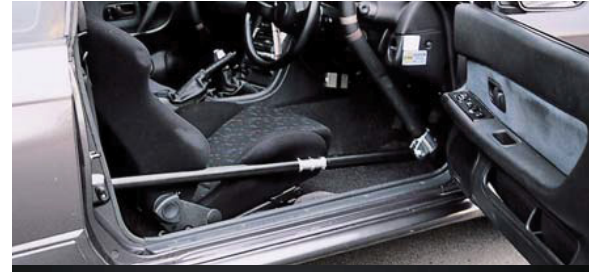

## ADD ON BAR

A7075 Aluminum Alloy Adjuster and Billet Aluminum Light Weight and Compact Rotary Buckle. 3-inch wide harness. FIA Approved.



### 6 Point : HANS Devices - 2 inch Shoulder Harness

- Part No: 00B CRH 6HBL : \$420 (MSRP) / each  
● BLUE
- Mush use with HANS Devices

### 6 Point : 3 inch Shoulder Harness

- Part No: 00B CRH 6BL : \$420 (MSRP) / each  
● BLUE
- Part No: 00B CRH 6BK : \$420 (MSRP) / each  
● BLACK

### 4 Point : 3 inch Shoulder Harness

- Part No: 00B CRH 4BL : \$420 (MSRP) / each  
● BLUE
- Part No: 00B CRH 4BK : \$420 (MSRP) / each  
● BLACK

### Anti-Submarine Belt : 2 inch Width

- Part No: 00B CCS 2BL : \$70 (MSRP) / each  
● BLUE
- Part No: 00B CCS 2BK : \$70 (MSRP) / each  
● BLACK

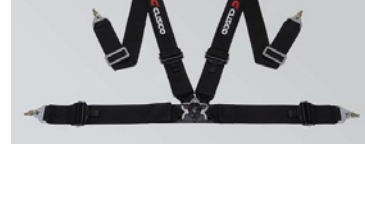
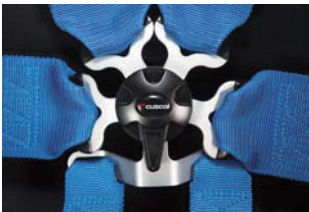



## UNIVERSAL FIT PARTS

### GT WING : SINGLE

#### A - Type

- Part No: 00B 821 AJA : \$427 (MSRP)
- 1310 mm Width
  - 217 mm Bracket (mount point)
  - 152 mm Bracket Height

#### B - Type

- Part No: 00B 821 AJB : \$427 (MSRP)
- 1460 mm Width
  - 217 mm Bracket (mount point)
  - 152 mm Bracket Height

#### C - Type

- Part No: 00B 821 AJC : \$427 (MSRP)
- 1410 mm Width
  - 217 mm Bracket (mount point)
  - 152 mm Bracket Height

#### D - Type

- Part No: 00B 821 AJD : \$427 (MSRP)
- 1310 mm Width
  - 170 mm Bracket (mount point)
  - 152 mm Bracket Height

#### E - Type

- Part No: 00B 821 AJE : \$427 (MSRP)
- 1460 mm Width
  - 170 mm Bracket (mount point)
  - 152 mm Bracket Height

#### F - Type

- Part No: 00B 821 AJF : \$427 (MSRP)
- 1410 mm Width
  - 170 mm Bracket (mount point)
  - 152 mm Bracket Height

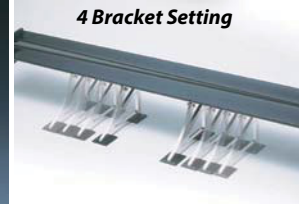
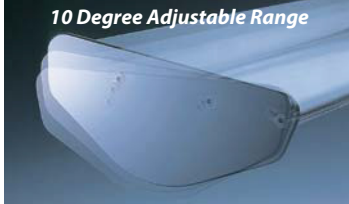

### SIDE SIL OPTION : ONLY for GT WING SINGLE

#### S - Size

- Part No: 00B 821 AS : \$64 (MSRP)
- 2 pcs set

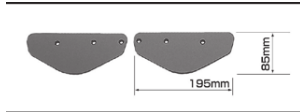

#### M - Size

- Part No: 00B 821 AM : \$64 (MSRP)
- 2 pcs set

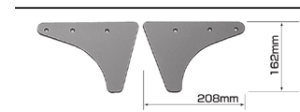

#### L - Size

- Part No: 00B 821 AL : \$64 (MSRP)
- 2 pcs set

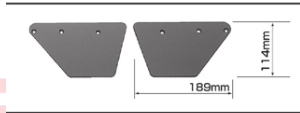

#### XL - Size

- Part No: 00B 821 AX : \$64 (MSRP)
- 2 pcs set

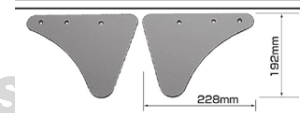

### GT WING : HIGH MOUNT TYPE

#### D - Type

- Part No: 00B 821 HJD : \$480 (MSRP)
- 1310 mm Width
  - 184 mm Bracket (mount point)
  - 235 mm Bracket Height

#### E - Type

- Part No: 00B 821 HJE : \$480 (MSRP)
- 1460 mm Width
  - 184 mm Bracket (mount point)
  - 235 mm Bracket Height

#### F - Type

- Part No: 00B 821 HJF : \$480 (MSRP)
- 1410 mm Width
  - 184 mm Bracket (mount point)
  - 235 mm Bracket Height



### GT WING : DUAL

#### A - Type

- Part No: 00B 822 AJA : \$640 (MSRP)
- 1320 mm Width
  - 217 mm Bracket (mount point)
  - 152 mm Bracket Height

#### B - Type

- Part No: 00B 822 AJB : \$640 (MSRP)
- 1470 mm Width
  - 217 mm Bracket (mount point)
  - 152 mm Bracket Height

#### C - Type

- Part No: 00B 822 AJC : \$640 (MSRP)
- 1420 mm Width
  - 217 mm Bracket (mount point)
  - 152 mm Bracket Height

#### D - Type

- Part No: 00B 822 AJD : \$640 (MSRP)
- 1320 mm Width
  - 170 mm Bracket (mount point)
  - 152 mm Bracket Height

#### E - Type

- Part No: 00B 822 AJE : \$640 (MSRP)
- 1470 mm Width
  - 170 mm Bracket (mount point)
  - 152 mm Bracket Height

#### F - Type

- Part No: 00B 822 AJF : \$640 (MSRP)
- 1420 mm Width
  - 170 mm Bracket (mount point)
  - 152 mm Bracket Height

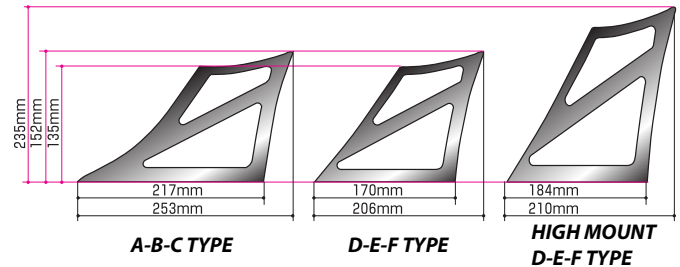

### SCISSORS JACK

- Part No: A547 DPJ 850DX : \$238 (MSRP)
- Max Capacity : 850 kg
  - Min Height : 121 mm
  - Max Height : 381 mm
  - Weight : 5.9 kg



### RIGID RACK - WRC STYLE

- Part No: 00B 004 A : \$200 (MSRP) / EACH
- Max Capacity : 1.5 t (use as set)
  - Min Height : 440 mm
  - Max Height : 540 mm
  - Width : 380 mm

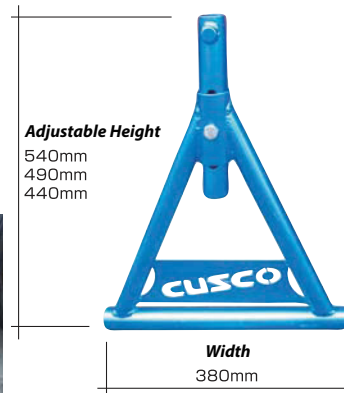



## UNIVERSAL FIT PARTS

### CENTER FLAP

- Part No: 00A 842 AR : \$174 (MSRP)
- RED
  - 150 mm x 330 mm
  - 2 pcs set

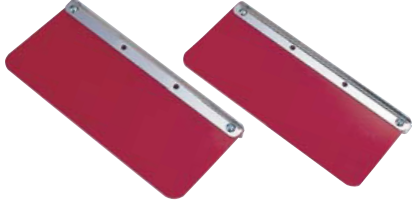

### URETHANE FLAP MATERIAL

- FIA Spec: 4 mm Thick**  
 Part No: 00A 932 R1 : \$374 (MSRP)
- RED
  - 1m x 1m

- Part No: 00A 932 R2 : \$734 (MSRP)
- RED
  - 1m x 2m

- 3 mm Thick**  
 Part No: 00A 930 C : \$320 (MSRP)
- RED
  - 1m x 1m

- Part No: 00A 931 C : \$600 (MSRP)
- RED
  - 1m x 2m



### JACK ASSIST RAMP SET

**Detachable Two-Piece Design ; Better Clearance for Floor Jacks ; Longer Ramp Distance / Mild Climb Angle ; Durable Lightweight ABS Material ; Made in Japan**

- Part No: A517 SL99 : \$98 (MSRP)
- Load Capacity : 800 kg / side
  - Made in Japan

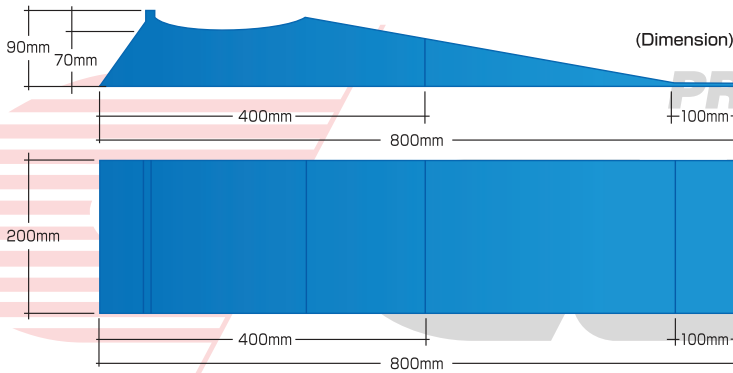

### SMART CROSS WRENCH

- Part No: 00B 060 A : \$54 (MSRP)
- Size: 12 Hex x 17mm x 19mm x 21mm
  - Deep & short socket design
  - Measurement: 400mm x 400mm
  - Weight: 900 grams
  - Torque Capability: 450 Nm (45.9 kgf.m)
  - Material: Chrome molybdenum
  - Finish: Durable melamine coat mirrored finish
  - Included: Case, CUSCO sticker
  - 100% MADE in JAPAN







## UNIVERSAL FIT PARTS

### CUSCO x BRIDE SEAT

#### ZETA III PLUS

- HANS Device Compatibility
- FIA Approved
- Black with Cusco Logo
- Carbon Aramid : 6.9 kg / 15 lbs
- FRP : 7.6 kg / 17 lbs

FRP Silver Shell   
 Part No: BRD-H31HCF : \$1,080 (MSRP)

Carbon Aramid Shell  
 Part No: BRD-H31HCR : \$2,150 (MSRP)



#### STRADIA II

- Steel Frame Structure
- Luxury Suede / Fire Retardant
- Low Cushion, Stitchless
- Silver FRP Construction
- Weight : 14 kg / 31 lbs

Standard Cushion  
 Part No: BRD-G33SCF : \$1,800 (MSRP)

Lowered Cushion  
 Part No: BRD-G23SCF : \$1,800 (MSRP)

#### STRADIA II : Type - XL

Standard Cushion  
 Part No: BRD-G55SCF : \$2,150 (MSRP)

#### GIAS II

High Side Bolster  
 Part No: BRD-G32SCF : \$1,800 (MSRP)



#### ZETA III : Sprot - C

FRP Black Shell  
 Part No: BRD-F31SCF : \$900 (MSRP)

**ZETA III**  - excludes Carbon Aramid Shell  
 FRP Silver Shell  
 Part No: BRD-F31HCF : \$1,000 (MSRP)

Super Aramid Shell  
 Part No: BRD-F31HCZ : \$1,400 (MSRP)

Carbon Aramid Shell  
 Part No: BRD-F31HCR : \$2,000 (MSRP)

**ZETA III : Typet - L**  - excludes Carbon Aramid Shell  
 FRP Silver Shell  
 Part No: BRD-FL1HCF : \$1,150 (MSRP)

Super Aramid Shell  
 Part No: BRD-FL1HCZ : \$1,500 (MSRP)

Carbon Aramid Shell  
 Part No: BRD-FL1HCR : \$2,200 (MSRP)

**ZETA III : Typet - XL**  - excludes Carbon Aramid Shell  
 FRP Silver Shell  
 Part No: BRD-F91HCF : \$1,150 (MSRP)

Super Aramid Shell  
 Part No: BRD-F91HCZ : \$1,500 (MSRP)

Carbon Aramid Shell  
 Part No: BRD-F91HCR : \$2,200 (MSRP)



#### DIGO III LIGHT

- Available with CRUZ (Armrest) Option
- Touring recliner
- Anatomically ergonomic seating
- Weight : 15.2 kg / 33 lbs

Part No: BRD-D45ACS : \$1,000 (MSRP)

#### DIGO III LIGHT - CRUZ

Part No: BRD-D44ACS : \$1,050 (MSRP)

#### CRUZ OPTIONAL ARM REST

Right Side  
 Part No: BRDA-P51ANN : \$75 (MSRP)

Left Side  
 Part No: BRDA-P52ANN : \$75 (MSRP)



#### VIOS III

- FIA Approved
- Black with Cusco Logo
- Carbon Aramid : 6.6 kg / 14.5 lbs
- Super Aramid : 7.1 kg / 15.5 lbs
- FRP Silver : 7.1 kg / 15.5 lbs
- FRP Black : 5.5 kg / 12.7 lbs

FRP Black Shell  
 Part No: BRD-F42SCF : \$900 (MSRP)

FRP Silver Shell   
 Part No: BRD-F42HCF : \$1,050 (MSRP)

Super Aramid Shell   
 Part No: BRD-F42HCZ : \$1,500 (MSRP)

Carbon Aramid Shell  
 Part No: BRD-F42HCR : \$2,050 (MSRP)



#### EUROSTER II

- Available with CRUZ (Armrest) Option
- Fireproof Material
- Weight : 16.1 kg / 35.5 lbs (one arm rest)

Part No: BRD-E32ACN : \$1,100 (MSRP)

#### EUROSTER II - CRUZ

Part No: BRD-E54ACN : \$1,150 (MSRP)

#### CRUZ OPTIONAL ARM REST

Right Side  
 Part No: BRDA-P51ANN : \$75 (MSRP)

Left Side  
 Part No: BRDA-P52ANN : \$75 (MSRP)





## UNIVERSAL FIT PARTS

### HELMET BAG

- Part No: CUS HLM BG : \$160 (MSRP)
- L x W x H : 30 x 40 x 40 cm
  - Shoulder Strap Included



### CFRP CARBON UMBRELLA

- Part No: CUS AA UMB2 : \$54 (MSRP)
- CFRP Carbon Shaft
  - Light Weight 650 g
  - Silver Cusco Logo
  - SPF Silver Backing Material
  - Length : 101 cm / OD : 134 cm
  - Polyester Outer Fabric

