

Installation for Toyota Tacoma PN-60593* (Extension Pipe for 140" Wheel Base)



These instructions have been written to help you with the installation of your Borla Performance Exhaust System. Please read this document completely before beginning the installation of your system.

Please compare the parts in the box with the bill of materials provided to assure that you have all the parts necessary for this installation.

To ensure this part number fits your specific model year, please visit our website for the latest model year listings at www.BORLA.com.

Thank you for purchasing a Borla Performance System.

Borla Performance Cat-Back™ Exhaust System (PN-60593) *fits only Borla 140680 for the Toyota Tacoma equipped with a 4.0L engine, 2WD or 4WD, Crew Cab/Short Bed or Extended Cab/Long Bed, automatic or manual transmissions. **Extends PN-140680 system to fit 140" Wheel Base vehicle.**

Borla Performance Industries recommends that an exhaust shop or professional after market parts installer perform the installation of this system. However, if you decide to perform the installation on your own it is recommended that two people are used. This installation should not be performed by one person due to the risk of injury. Ensure the installers use all under car safety precautions including eye protection.

Please take time to read and understand the following...

By installing your Borla Performance Exhaust System, you indicate that you have read this document and you agree with the terms stated below. It is the responsibility of the purchaser to follow all installation instruction guidelines and safety procedures supplied with your Borla Performance Exhaust System.

Borla Performance Industries assumes no responsibility for damages occurring from misuse, abuse, improper installation, improper operation, lack of responsible care, or all previously stated reasons resulting from incompatibility with other manufacturer's products and/or systems.

Included with your Borla Performance Exhaust System is a warranty card. Please read it carefully before you begin any work on your vehicle. If you should have any questions regarding our warranty policy, installation, or any other matter pertaining to your new Borla Performance Exhaust System, please give us a call at the number provided on the warranty card.

Minimum Required Tool List:

TOOLS:

1. 3/8" Drive Ratchet
2. 3/8" Drive Extension 3"
3. 15mm Socket
4. Pry Bar

SHOP SUPPLIES:

- 1 Spray Lubricant

Borla Performance Bill of Materials

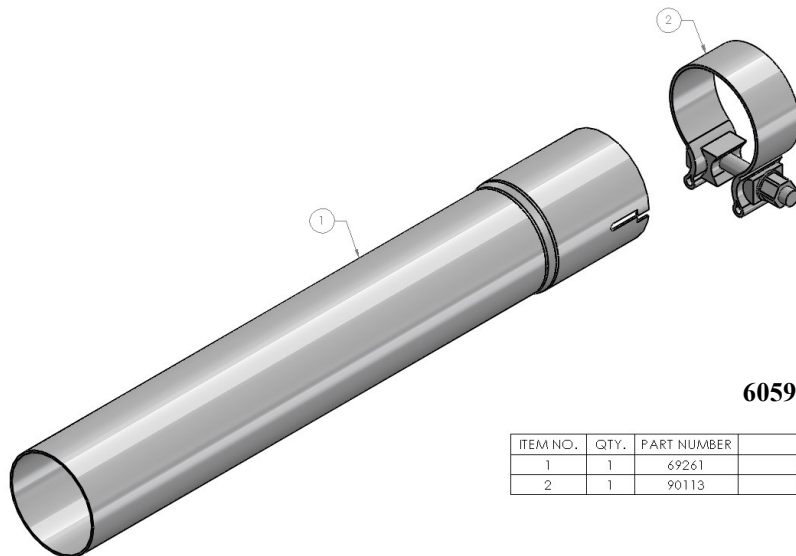

60593

ITEM NO.	QTY.	PART NUMBER	DESCRIPTION
1	1	69261	EXTENSION PIPE;Ø2.50 X 16.63"
2	1	90113	S/S ACCUSEAL CLAMP Ø2.50

Caution!!! *Never* work on a hot exhaust system. Serious injury in the form of burns can result if the vehicle has been in use and the exhaust system is hot, allow vehicle to cool for at least 1 hour. Always wear eye protection when working under any vehicle.

Note: It is our recommendation that you use a hoist or hydraulic lift to facilitate the installation of your new Borla Performance Exhaust System.

Taking all under car safety precautions, lift the vehicle using a hoist or hydraulic lift. Once this has been done, you may begin the removal of your old exhaust system from your vehicle.

Note: Before removing the original exhaust system from your vehicle, please compare the parts you have received with the bill of materials provided on the previous page to assure that you have all the parts necessary for the installation of your new Borla Performance Exhaust System.

Note: With a used vehicle, we suggest a penetrating spray lubricant to be applied liberally to all exhaust fasteners and allowing a significant period of time for the chemical to lubricate the threads before attempting to disassemble.

Original Exhaust System Removal

1. Unbolt and remove flange hardware located behind the catalytic converters. Keep hardware for use during the reinstallation of your new system. (See Fig. 1)
2. Carefully remove the gasket from OE exhaust and keep it for reinstallation of your new system. (See Fig. 2)
3. Using a muffler stand or help of an additional person to hold the muffler into position, carefully remove the hangers from rubber isolator. (See Fig. 3)
4. Carefully remove hanger from rubber isolator on tail-pipe. (See Fig. 4)
5. Original exhaust system removed. (See Fig. 5)

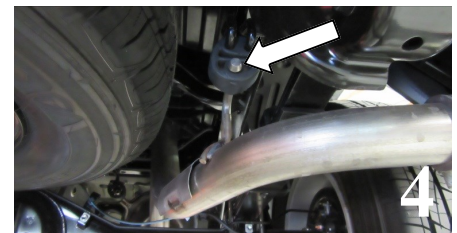
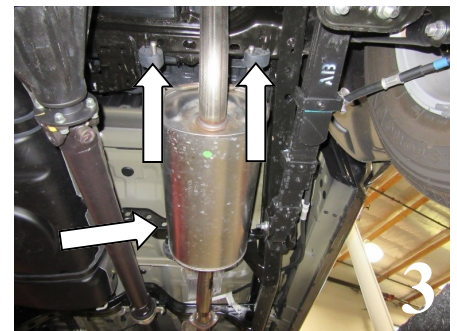
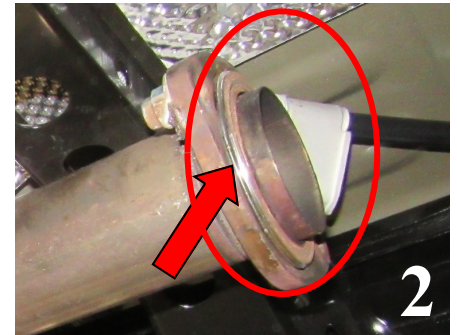
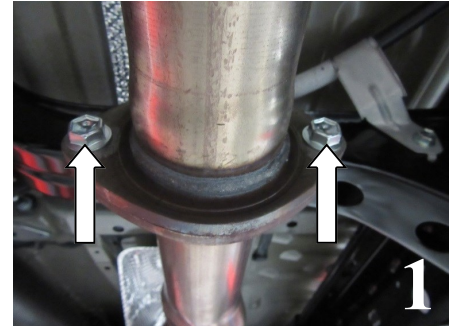

WARNING: Use extreme caution during installation. Torque all fasteners according to manufacturer's torque values and tightening sequence. **DO NOT** use air impact tools to tighten fasteners on Borla Performance Exhaust Systems. Use of such tools may result in bent flanges or gasket contact areas leading to exhaust leaks.

NOTE: When you first start your vehicle after the installation of your new Borla Performance Exhaust System, there may be some smoke and fumes coming from the system. This is a protective oil based coating used in the manufacturing of mandrel bent performance exhaust tubing. This is not a problem and will disappear within a very short period of time after the exhaust has reached normal operating temperatures.

Borla Performance Cat-Back™ Exhaust System Installation

1. Transfer the OE gasket to new flange. Use the original hardware and install **Front Pipe Assembly** to factory flange. Hand-tighten hardware. (See Fig. 6)
2. **FOR 140" WHEEL BASE ONLY:** Place a clamp over the expanded end of (60570) **Extension Pipe Assembly** and insert to **Front Pipe Assembly**. **Do not tighten the clamp.**
3. Place a clamp over the expanded end of the **Muffler Assembly** inserting hangers into the rubber isolators. (See Fig. 7) **Do Not Tighten the clamp.**
4. Place a clamp over the expanded end of the tail-pipe assembly and set it into position installing the hanger into the rubber isolator. (See Fig. 8) **Do Not Tighten the clamp.**
5. Check your exhaust system for proper clearance under the vehicle and also for tip alignment. (See. Fig. 9)
6. Once position has been determined to be correct, tighten the flange hardware to 18-22 ft. lbs. Tighten clamp bolt 33-35 ft. lb.
7. Before starting your vehicle, make sure to check all wires, hoses, brake lines, body parts and tires for safe clearance from the exhaust system.
8. Start vehicle and check for any leaks. If any leaks are found, determine cause and repair as necessary.

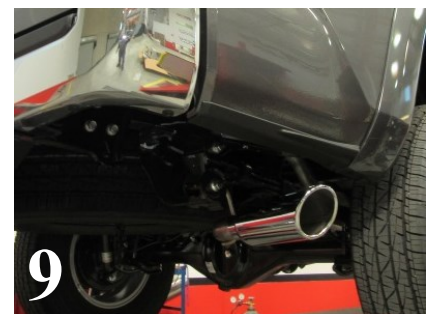
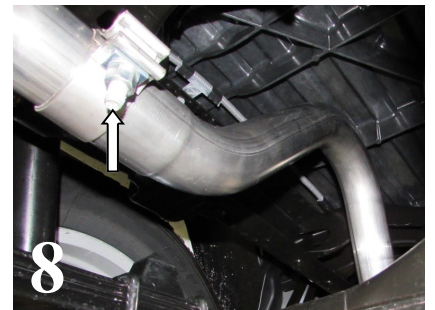
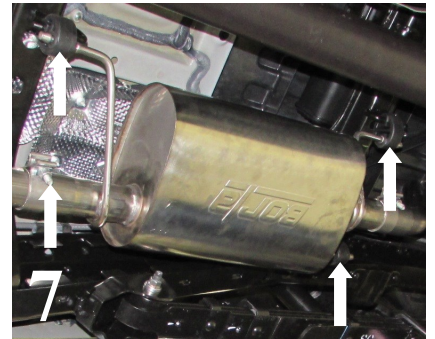
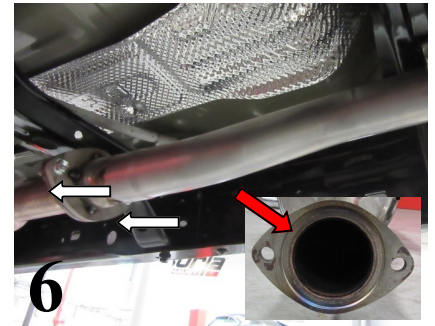

WARNING: Use extreme caution during installation. Torque all fasteners according to manufacturer's torque values and tightening sequence. **DO NOT** use air impact tools to tighten fasteners on Borla Performance Exhaust Systems. Use of such tools may result in bent flanges or gasket contact areas leading to exhaust leaks.

NOTE: When you first start your vehicle after the installation of your new Borla Performance Exhaust System, there may be some smoke and fumes coming from the system. This is a protective oil based coating used in the manufacturing of mandrel bent performance exhaust tubing. This is not a problem and will disappear within a very short period of time after the exhaust has reached normal operating temperatures.