

## Installation for Porsche Cayman/Boxster (981) PN-140534



**These instructions have been written to help you with the installation of your Borla Performance Exhaust System. Please read this document completely before beginning the installation of your system.**

**Please compare the parts in the box with the bill of materials provided to assure that you have all the parts necessary for this installation.**

**To ensure this part number fits your specific model year, please visit our website for the latest model year listings at [www.BORLA.com](http://www.BORLA.com).**

**Thank you for purchasing a Borla Performance Exhaust System.**

**Borla Performance Cat-Back™ Exhaust System (140534) is designed for the Porsche Cayman/Boxster with 2.7L & 3.4L 6-cylinder engines, automatic/manual transmissions**

Borla Performance Industries recommends that an exhaust shop or professional after market parts installer perform the installation of this system. However, if you decide to perform the installation on your own it is recommended that two people are used. This installation should not be performed by one person due to the risk of injury. Ensure the installers use all under car safety precautions including eye protection.

*Please take time to read and understand the following...*

By installing your Borla Performance Exhaust System, you indicate that you have read this document and you agree with the terms stated below.

It is the responsibility of the purchaser to follow all installation instruction guidelines and safety procedures supplied with your Borla Performance Exhaust System

Borla Performance Industries assumes no responsibility for damages occurring from misuse, abuse, improper installation, improper operation, lack of responsible care, or all previously stated reasons resulting from incompatibility with other manufacturer's products and/or systems.

Included with your Borla Performance Exhaust System is a warranty card. Please read it carefully before you begin any work on your vehicle. If you should have any questions regarding our warranty policy, installation, or any other matter pertaining to your new Borla Performance Exhaust System, please give us a call at the number provided on the warranty card.

**Minimum Required Tool List:**

**TOOLS:**

1. 3/8" Drive Ratchet
2. 3/8" Drive Extension 3"
3. 13mm, 14mm sockets
4. 15mm Deep Well Socket
5. Pry Bar

**SHOP SUPPLIES:**

- 1 Spray Lubricant

**Borla Performance - Bill of Materials**

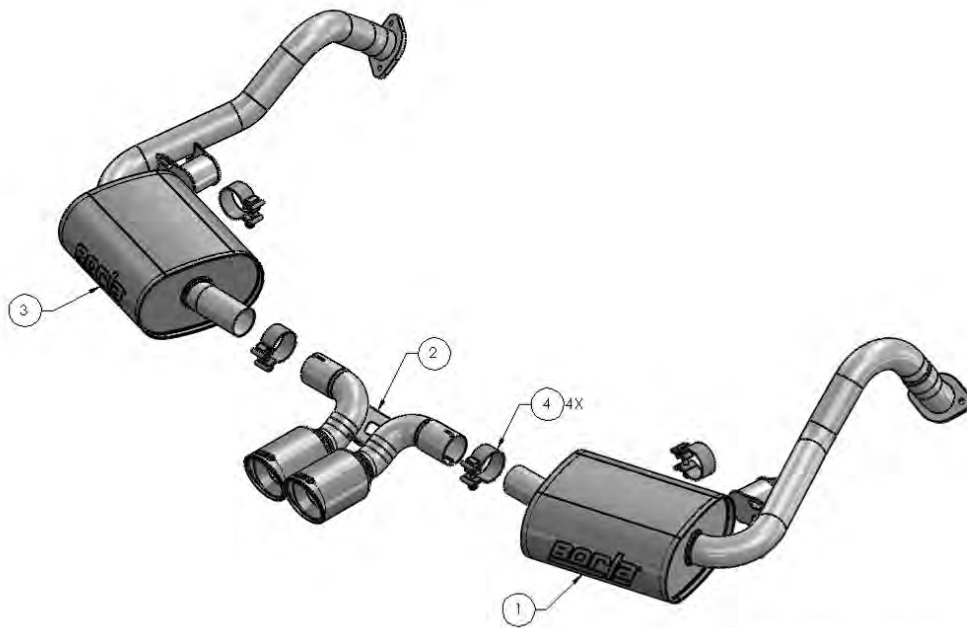

140534

ITEM NO.	QTY.	PART NUMBER	DESCRIPTION
1	1	55116	R/H MUFFLER ASSEMBLY
2	1	55117	TIP ASSEMBLY
3	1	55118	L/H MUFFLER ASSEMBLY
4	4	90112	S/S ACCUSEAL CLAMP Ø2.25

**Caution!!!** *Never work on a hot exhaust system. Serious injury in the form of burns can result* If the vehicle has been in use and the exhaust system is hot, allow vehicle to cool for at least 1 hour. Always wear eye protection when working under any vehicle.

*Note: It is our recommendation that you use a hoist or hydraulic lift to facilitate the installation of your new Borla Performance Cat-Back™ Exhaust System.*

Taking all under car safety precautions, lift the vehicle using a hoist or hydraulic lift. Once this has been done, you may begin the removal of your old exhaust system from your vehicle.

*Note: Before removing the original exhaust system from your vehicle, please compare the parts you have received with the bill of materials provided on the previous page to assure that you have all the parts necessary for the installation of your new Borla Performance Cat-Back™ Exhaust System.*

## Original Exhaust System Removal

*Note: With a used vehicle, we suggest a penetrating spray lubricant to be applied liberally to all exhaust fasteners and allowing a significant period of time for the chemical to lubricate the threads before attempting to disassemble.*

1. Lubricate all the hangers and rubber isolators.
2. Loosen and remove (3) muffler support-bar bolts. **Keep factory hardware for reinstallation.** (See Figs. 2& 3)
3. Loosen and remove manifold flange bolts. **Keep factory hardware for reinstallation** (See Fig. 3)
4. Loosen band clamp and tip assembly hardware to allow muffler pipe removal. (See Fig. 4)
5. Remove left-side exhaust from vehicle. Remove band-clamp and tip assembly. Remove right-side exhaust from vehicle.

**Warning:** Use extreme caution during installation. Torque all fasteners according to manufacturer's torque values and tightening sequence. **DO NOT** use air impact tools to tighten fasteners on Borla Performance Exhaust Systems. Use of such tools may result in bent flanges or gasket contact areas leading to exhaust leaks.

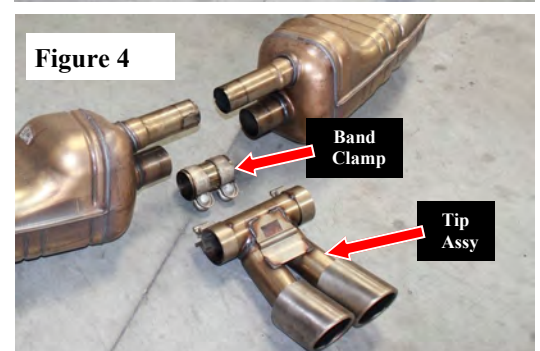
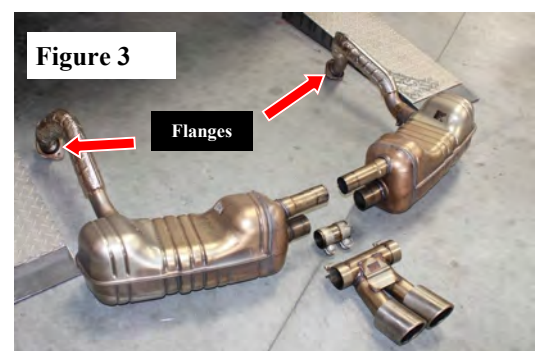
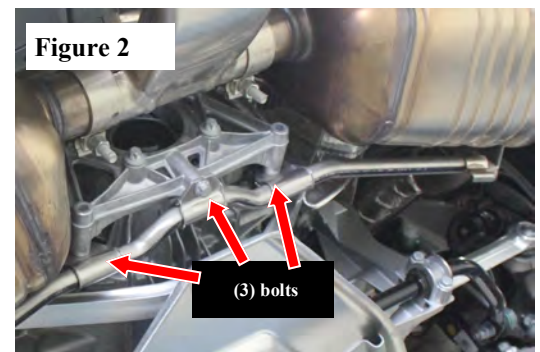

**Caution!!!** *Never work on a hot exhaust system. Serious injury in the form of burns can result* If the vehicle has been in use and the exhaust system is hot, allow vehicle to cool for at least 1 hour. Always wear eye protection when working under any vehicle.

*Note: It is our recommendation that you use a hoist or hydraulic lift to facilitate the installation of your new Borla Performance Cat-Back™ Exhaust System.*

Taking all under car safety precautions, lift the vehicle using a hoist or hydraulic lift. Once this has been done, you may begin the removal of your old exhaust system from your vehicle.

*Note: Before removing the original exhaust system from your vehicle, please compare the parts you have received with the bill of materials provided on the previous page to assure that you have all the parts necessary for the installation of your new Borla Performance Cat-Back™ Exhaust System.*

## Borla Performance Rear Section Exhaust System Installation

1. Refer to page 2 drawing for orientation of components. Your Borla cat-back should be assembled on a protected flat surface for ease of assembly. Later it will be lifted into position where hardware is properly aligned and torqued.
2. Place (2) clamps on L/H Muffler and R/H Muffler Assemblies and insert Tip Assembly into pipe nipples. Lightly tighten clamps. (See Fig. 5) Assemble muffler support bar to Muffler Assembly using (2) clamps provided and tightening to 35-ft lbs.
3. With assistance of a helper and using muffler support stands, position assembled cat-back to vehicle. Use original hardware and connect flanges to manifolds. Attach muffler support bar using factory hardware. (See Fig. 6) Tighten bolts.
4. Check your exhaust for proper clearance under the vehicle and also for tip alignment. Begin tightening cat-back system beginning at flange bolts. Next, center Tip Assembly and tighten clamp 35-ft.lbs. (See Fig. 7 & 8)
5. Start vehicle and check for any leaks. If any leaks are found, determine cause (such as loose hardware) and repair as necessary.

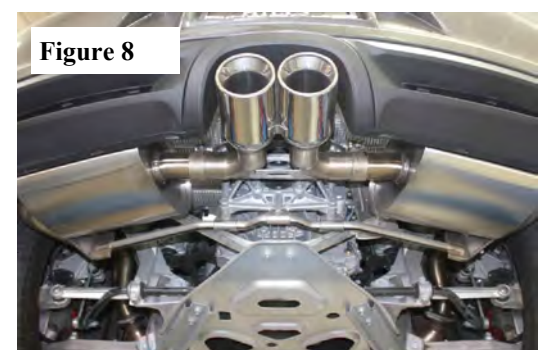
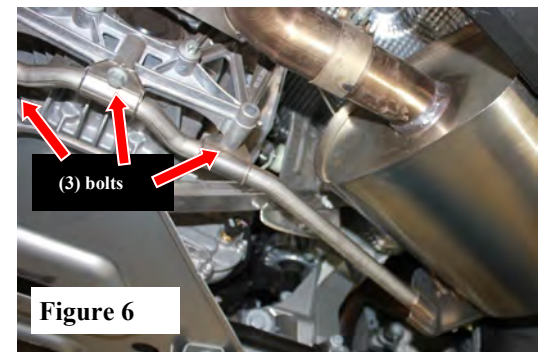
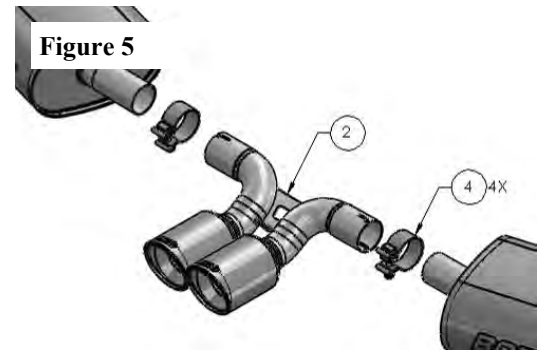

\*\*\*\*\* **Please refer to factory-recommended bolt torque specifications when tightening original hardware** \*\*\*\*\*

***NOTE: When you first start your vehicle after the installation of your new Borla Performance Exhaust System, there may be some smoke and fumes coming from the system. This is a protective oil based coating used in the manufacturing of mandrel bent performance exhaust tubing. This is not a problem and will disappear within a very short period of time after the exhaust has reached normal operating temperatures.***