

## Exhaust System Instructions for Porsche Carrera PN-140524, 140710



**\*\*\*\*\* Please compare the parts in the box with the bill of materials provided \*\*\*\*\*  
to assure that you have all the parts necessary for this installation.**

These instructions have been written to help you with the installation of your Borla Performance Exhaust System. Please read this document completely before beginning the installation of your system.

To ensure this part number fits your specific model year, please visit our website for the latest model year listings at [www.BORLA.com](http://www.BORLA.com)

**Thank you for purchasing a Borla Performance Exhaust System.**

**Borla Performance Cat-back Exhaust System (PN-140524) is designed for the Porsche 911(991) Carrera 3.4L or 3.8L 6-cylinder engine, manual or automatic transmission, uses Borla 4-tips.**

**Borla Performance Cat-back Exhaust System (PN-140710 ) is designed for the Porsche 911(991) Carrera 3.4L or 3.8L 6-cylinder engine, manual or automatic transmission, uses clamp-on stock tips.**

Borla Performance Industries recommends that an exhaust shop or professional after market parts installer perform the installation of this system. However, if you decide to perform the installation on your own it is recommended that two people are used. This installation should not be performed by one person due to the risk of injury. Ensure the installers use all under car safety precautions including eye protection.

*Please take time to read and understand the following...*

By installing your Borla Performance Exhaust System, you indicate that you have read this document and you agree with the terms stated below.

It is the responsibility of the purchaser to follow all installation instruction guidelines and safety procedures supplied with your Borla Performance Exhaust System.

Borla Performance Industries assumes no responsibility for damages occurring from misuse, abuse, improper installation, improper operation, lack of responsible care, or all previously stated reasons resulting from incompatibility with other manufacturer's products and/or systems.

Included with your Borla Performance Exhaust System is a warranty card. Please read it carefully before you begin any work on your vehicle. If you should have any questions regarding our warranty policy, installation, or any other matter pertaining to your new Borla Performance Exhaust System, please give us a call at the number provided on the warranty card.

**Minimum Required Tool List:**

**TOOLS:**

1. 3/8" Drive Ratchet
2. 3/8" Drive Extension 3"
3. 15mm Socket
4. 14mm Socket
5. 13mm Socket
6. 10mm Socket
7. Pry Bar

**SHOP SUPPLIES:**

- 1 Spray Lubricant

**Borla Performance - Bill of Materials**

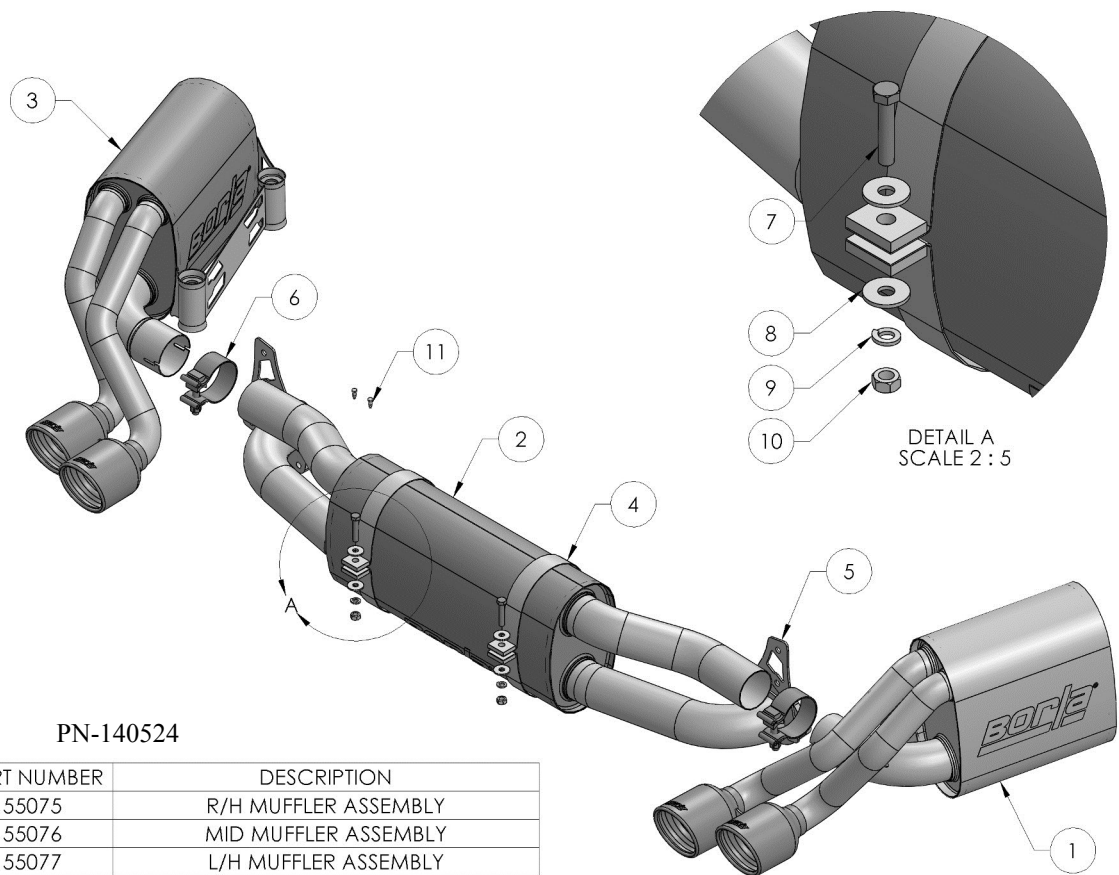

PN-140524

ITEM NO.	QTY.	PART NUMBER	DESCRIPTION
1	1	55075	R/H MUFFLER ASSEMBLY
2	1	55076	MID MUFFLER ASSEMBLY
3	1	55077	L/H MUFFLER ASSEMBLY
4	2	55044	MUFFLER STRAP ASSEMBLY
5	2	72197	BRACKET: 3.91" X .125" THK. X 6.58"
6	2	90113	S/S ACCUSEAL CLAMP $\phi$ 2.50
7	2	91048	SCREW:CAP, HEXHD, M8 X 40mm, 1.25p
8	4	92028	FLAT WASHER: M8
9	2	92025	8MM LOCK WASHER
10	2	93005	HEXNUT: 8MM X 1.25 PITCH
11	2	98539	VACUUM PLUG

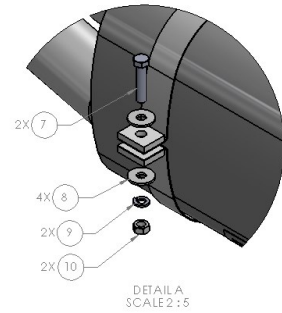
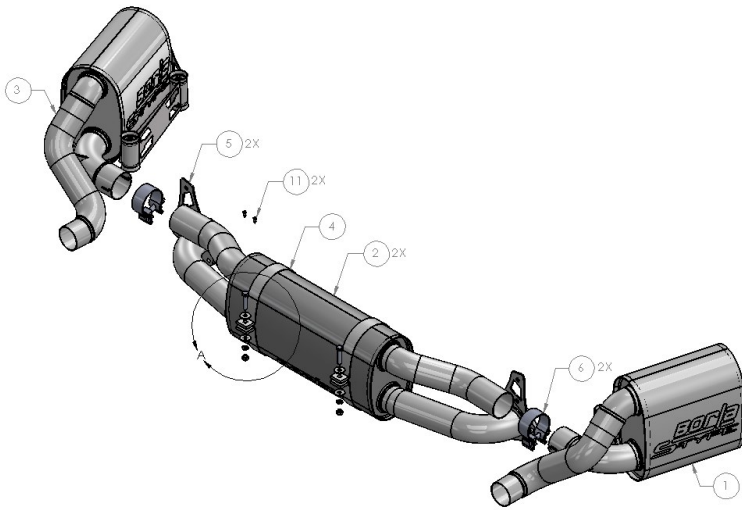

**PN-140710**

ITEM NO.	QTY.	PART NUMBER	DESCRIPTION
1	1	56468	R/H MUFFLER ASSEMBLY
2	1	55076	MID MUFFLER ASSEMBLY
3	1	56469	L/H MUFFLER ASSEMBLY
4	2	55044	MUFFLER STRAP ASSEMBLY
5	2	72197	BRACKET: 3.91" X .125" THK. X 6.58"
6	2	90113	S/S ACCUSEAL CLAMP Ø2.50
7	2	91048	SCREW: CAP, HEXHD, M8x40MM, 1.25p
8	4	92028	FLAT WASHER: M8
9	2	92025	WASHER:LOCK, M8 SPRING
10	2	93005	NUT: HXHD, M8 X 1.25 PITCH
11	2	98539	VACUUM PLUG

**Caution!!!** *Never work on a hot exhaust system. Serious injury in the form of burns can result if the vehicle has been in use and the exhaust system is hot, allow vehicle to cool for at least 1 hour. Always wear eye protection when working under any vehicle.*

**Note:** *It is our recommendation that you use a hoist or hydraulic lift to facilitate the installation of your new Borla Performance Exhaust System.*

**Taking all under car safety precautions, lift the vehicle using a hoist or hydraulic lift. Once this has been done, you may begin the removal of your old exhaust system from your vehicle.**

**Note:** *Before removing the original exhaust system from your vehicle, please compare the parts you have received with the bill of materials provided on the previous page to assure that you have all the parts necessary for the installation of your new Borla Performance Exhaust System.*

**Note:** *With a used vehicle, we suggest a penetrating spray lubricant to be applied liberally to all exhaust fasteners and allowing a significant period of time for the chemical to lubricate the threads before attempting to disassemble.*

## Original Exhaust System Removal

1. Remove the factory tips clamp by loosening the bolts. (See Figs. 1 & 2)
2. Loosen left-side and right-side clamp muffler bolts on center muffler. (See Fig. 3)
3. Carefully remove left-side and right nipples of center muffler. (See Fig. 4)
4. Loosen (3) nuts on left-side flange of center muffler. (See Fig. 5)
5. Loosen (3) nuts on right-side flange of center muffler.

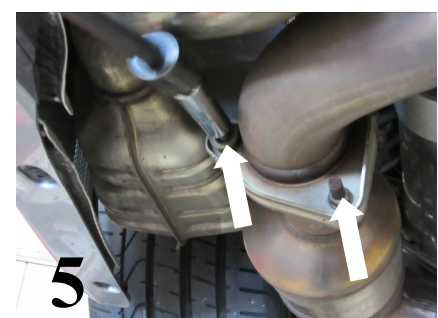
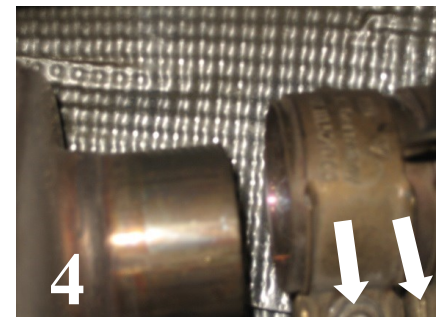
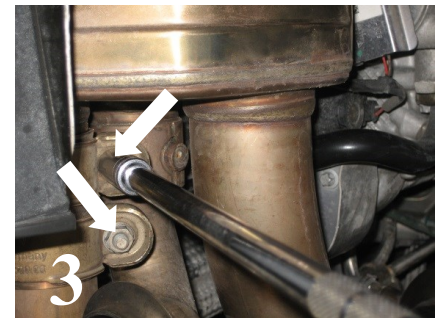
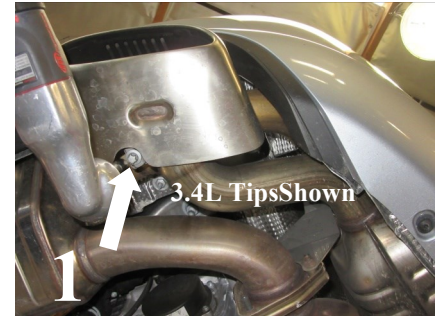

**Caution!!!** *Never work on a hot exhaust system. Serious injury in the form of burns can result. If the vehicle has been in use and the exhaust system is hot, allow vehicle to cool for at least 1 hour. Always wear eye protection when working under any vehicle.*

**Note:** *It is our recommendation that you use a hoist or hydraulic lift to facilitate the installation of your new Borla Performance Exhaust System.*

**Taking all under car safety precautions, lift the vehicle using a hoist or hydraulic lift. Once this has been done, you may begin the removal of your old exhaust system from your vehicle.**

**Note:** *Before removing the original exhaust system from your vehicle, please compare the parts you have received with the bill of materials provided on the previous page to assure that you have all the parts necessary for the installation of your new Borla Performance Exhaust System.*

**Note:** *With a used vehicle, we suggest a penetrating spray lubricant to be applied liberally to all exhaust fasteners and allowing a significant period of time for the chemical to lubricate the threads before attempting to disassemble.*

## Original Exhaust System Removal (continued)

6. Remove R/H & L/H manifold bolts (See Fig. 6)
7. Remove R/H & L/H manifolds and tie them up with string or cable ties to avoid damage to wiring. (See Fig. 7)
8. Manifold should look like this on both sides. (See Fig. 8)
9. Loosen and move strap aside to allow center muffler to be removed. (See Fig. 9)

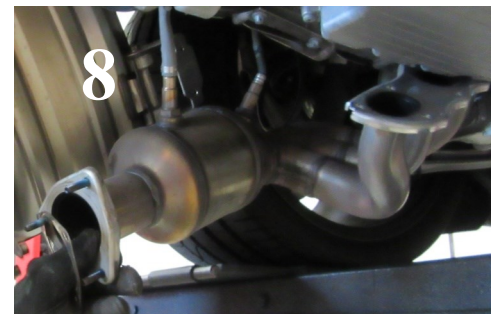
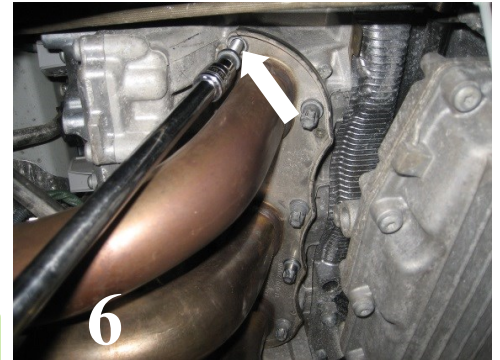

**Caution!!!** *Never work on a hot exhaust system. Serious injury in the form of burns can result. If the vehicle has been in use and the exhaust system is hot, allow vehicle to cool for at least 1 hour. Always wear eye protection when working under any vehicle.*

**Note:** *It is our recommendation that you use a hoist or hydraulic lift to facilitate the installation of your new Borla Performance Exhaust System.*

**Taking all under car safety precautions, lift the vehicle using a hoist or hydraulic lift. Once this has been done, you may begin the removal of your old exhaust system from your vehicle.**

**Note:** *Before removing the original exhaust system from your vehicle, please compare the parts you have received with the bill of materials provided on the previous page to assure that you have all the parts necessary for the installation of your new Borla Performance Exhaust System.*

**Note:** *With a used vehicle, we suggest a penetrating spray lubricant to be applied liberally to all exhaust fasteners and allowing a significant period of time for the chemical to lubricate the threads before attempting to disassemble.*

## Original Exhaust System Removal (continued)

10. Remove center muffler from vehicle. (See Fig. 10)
11. Remove hanger bolts (2) on R/H side as shown. (See Fig. 11)
12. Duplicate the operation on the L/H side. (See Fig. 12) Access can be difficult you may wish to utilize the technique shown in Figure 13.
13. Remove R/H muffler assembly from vehicle.
14. Remove L/H muffler assembly from vehicle.

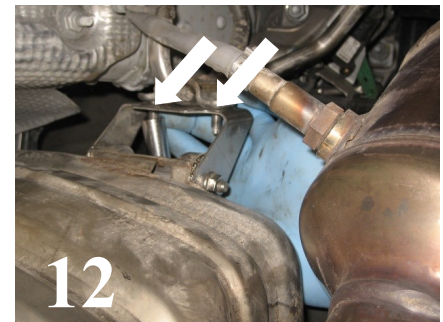
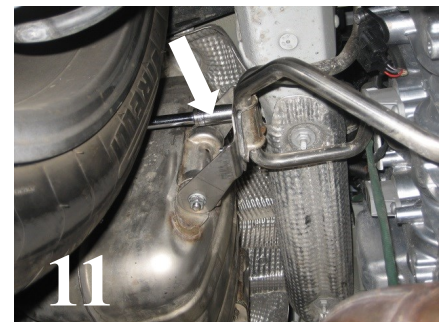

## Borla Performance Exhaust System Installation

15. Place OEM muffler sections and clamps aside. (See Fig. 15)
16. Remove hanger brackets from both muffler sections (See Fig. 16)
17. The brackets need to be reinstalled properly, do not mix up or disorient (See Fig. 17).
18. Set brackets aside to re-use. (See Fig. 18)
19. Remove steel mesh isolators and spacer tube to re-use. (See Fig. 19)

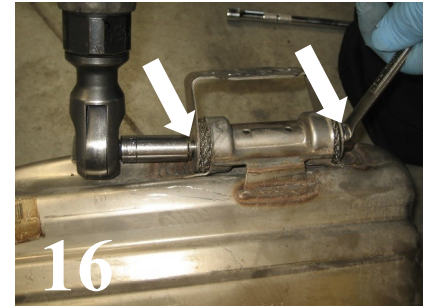
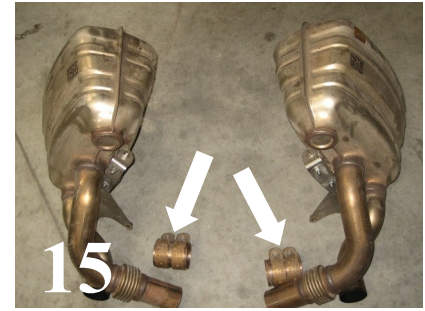

**WARNING:** Use extreme caution during installation. Torque all fasteners according to manufacturer's torque values and tightening sequence. **DO NOT** use air impact tools to tighten fasteners on Borla Performance Exhaust Systems. Use of such tools may result in bent flanges or gasket contact areas leading to exhaust leaks.

**NOTE:** When you first start your vehicle after the installation of your new Borla Performance Exhaust System, there may be some smoke and fumes coming from the system. This is a protective oil based coating used in the manufacturing of mandrel bent performance exhaust tubing. This is not a problem and will disappear within a very short period of time after the exhaust has reached normal operating temperatures.

## Borla Performance Exhaust System Installation (continued)

20. Install steel mesh isolator, spacer, and bracket duplicating OEM orientation. (See Fig. 20)
21. Assemble OEM bracket to Borla bracket as shown. (See Fig. 21)
22. Finished assembly will be as shown (See Fig. 22)
23. Finish tightening nuts on back plate. (See Fig. 23)

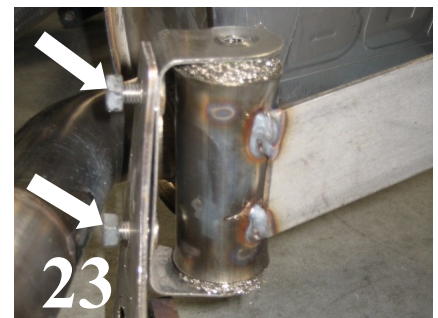
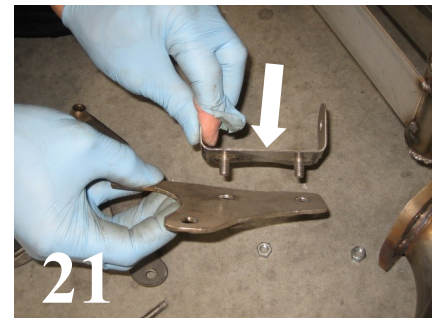

**WARNING:** Use extreme caution during installation. Torque all fasteners according to manufacturer's torque values and tightening sequence. **DO NOT** use air impact tools to tighten fasteners on Borla Performance Exhaust Systems. Use of such tools may result in bent flanges or gasket contact areas leading to exhaust leaks.

**NOTE:** When you first start your vehicle after the installation of your new Borla Performance Exhaust System, there may be some smoke and fumes coming from the system. This is a protective oil based coating used in the manufacturing of mandrel bent performance exhaust tubing. This is not a problem and will disappear within a very short period of time after the exhaust has reached normal operating temperatures.



## Borla Performance Exhaust System Installation (continued)

24. Install OEM through bolt back into isolator assembly attaching the isolators to the mufflers. (See Fig. 24)
25. Assemble the three muffler sections together as shown. (See Fig. 25)
26. Use a muffler stand or another person to assist in holding the assembly in position. (See Fig. 26)
27. Align muffler hangers to the appropriate mounts on the vehicle, tighten fasteners as shown. (See Fig. 27)



**WARNING:** Use extreme caution during installation. Torque all fasteners according to manufacturer's torque values and tightening sequence. **DO NOT** use air impact tools to tighten fasteners on Borla Performance Exhaust Systems. Use of such tools may result in bent flanges or gasket contact areas leading to exhaust leaks.

**NOTE:** When you first start your vehicle after the installation of your new Borla Performance Exhaust System, there may be some smoke and fumes coming from the system. This is a protective oil based coating used in the manufacturing of mandrel bent performance exhaust tubing. This is not a problem and will disappear within a very short period of time after the exhaust has reached normal operating temperatures.

## Borla Performance Exhaust System Installation (continued)

28. Install manifold gaskets back on assembly. (See Fig. 28)
29. Replace manifolds, start by working the manifolds in from the 3 bolt flange side. (See Fig. 29)
30. Be sure to place the mounting brackets over the mounting studs as shown. (See Fig. 30)
31. Replace all fasteners loosely. (See Fig. 31)
32. Once all fasteners have been installed, tighten to factory specifications. (See Fig. 32)

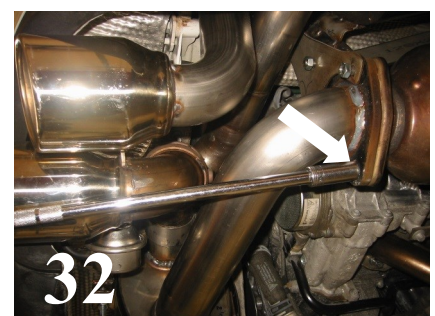
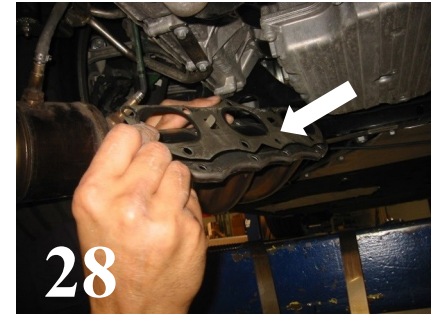

**WARNING:** Use extreme caution during installation. Torque all fasteners according to manufacturer's torque values and tightening sequence. **DO NOT** use air impact tools to tighten fasteners on Borla Performance Exhaust Systems. Use of such tools may result in bent flanges or gasket contact areas leading to exhaust leaks.

**NOTE:** When you first start your vehicle after the installation of your new Borla Performance Exhaust System, there may be some smoke and fumes coming from the system. This is a protective oil based coating used in the manufacturing of mandrel bent performance exhaust tubing. This is not a problem and will disappear within a very short period of time after the exhaust has reached normal operating temperatures.

## Borla Performance Exhaust System Installation (continued)

33. The mounting straps will be assembled on the vehicle as shown. It is a good idea to assemble and then take one apart again to be familiar with the parts involved and pre form the strap . (See Fig. 33)
34. Place both straps at the ends of the center muffler as shown and tighten to 12ft.lbs. (See Fig. 34)
35. Be sure that the tips are properly aligned in the opening so as to not melt the plastic. (See Figs. 35 & 36)
36. Install R/H & L/H side OEM tips on the **PN#140710**. (See Fig. 37 & 38)

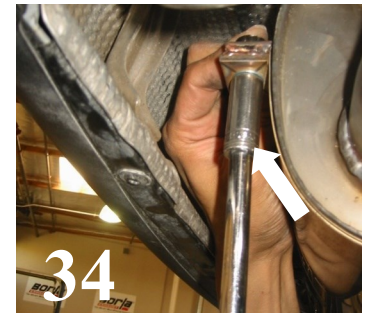

**WARNING:** Use extreme caution during installation. Torque all fasteners according to manufacturer's torque values and tightening sequence. **DO NOT** use air impact tools to tighten fasteners on Borla Performance Exhaust Systems. Use of such tools may result in bent flanges or gasket contact areas leading to exhaust leaks.

**NOTE:** When you first start your vehicle after the installation of your new Borla Performance Exhaust System, there may be some smoke and fumes coming from the system. This is a protective oil based coating used in the manufacturing of mandrel bent performance exhaust tubing. This is not a problem and will disappear within a very short period of time after the exhaust has reached normal operating temperatures.