

Exhaust System Installation

PN's: 140125 & 140407



These instructions have been written to help you with the installation of your Borla Performance Exhaust System. Please read this document completely before beginning the installation of your system.

Please compare the parts in the box with the bill of materials provided to assure that you have all the parts necessary for this installation.

To ensure this part number fits your specific model year, please visit our website for the latest model year listings at www.BORLA.com.

Thank you for purchasing a Borla Performance Exhaust System.

Borla Performance Cat-Back™ Exhaust System (140125) is designed for Dodge Magnum/Charger and Chrysler 300C equipped with a 5.7L Hemi V-8 engine and automatic transmission.

Borla Performance ATAK Cat-Back™ Exhaust System (140407) is designed for Dodge Magnum/Charger and Chrysler 300C SRT-8 equipped with a 6.2L Hemi V-8 engine and automatic transmissions.

Please take time to read and understand the following...

By installing your Borla Performance Exhaust System, you indicate that you have read this document and you agree with the terms stated below.

It is the responsibility of the purchaser to follow all installation instruction guidelines and safety procedures supplied with your Borla Performance Exhaust System.

Borla Performance Industries assumes no responsibility for damages occurring from misuse, abuse, improper installation, improper operation, lack of responsible care, or all previously stated reasons resulting from incompatibility with other manufacturer's products and/or systems.

Included with your Borla Performance Exhaust System is a warranty card. Please read it carefully before you begin any work on your vehicle. If you should have any questions regarding our warranty policy, installation, or any other matter pertaining to your new Borla Performance Exhaust System, please give us a call at the number provided on the warranty card.

Minimum Required Tool List:

TOOLS:

1. 3/8" Drive Ratchet
2. 3/8" Drive Extension 3"
3. 15mm Socket
4. 13mm Socket
5. Pry Bar

SHOP SUPPLIES:

- 1 Spray Lubricant

Borla Performance Cat-back™ Bill of Materials

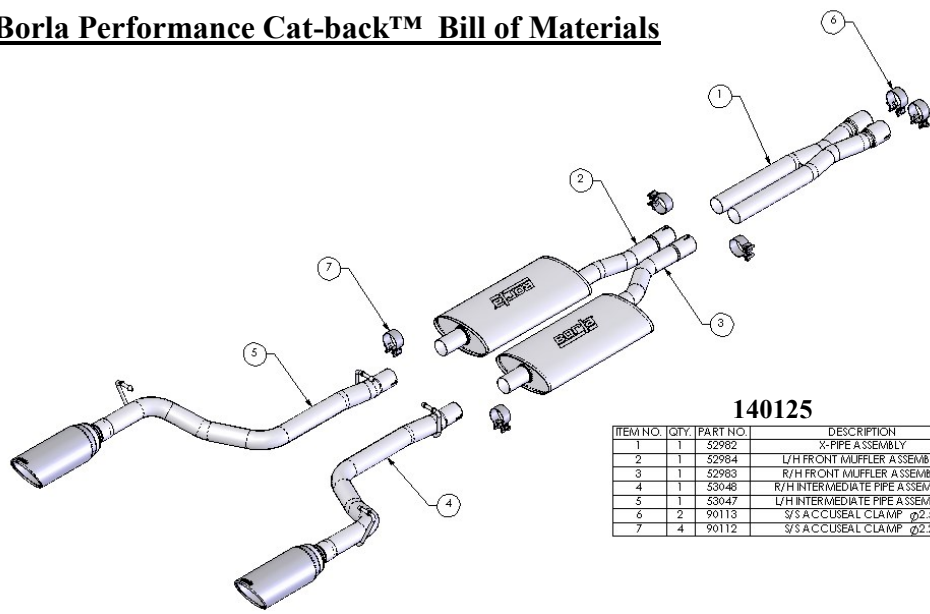

140125

ITEM NO.	QTY.	PART NO.	DESCRIPTION
1	1	52952	X-PIPE ASSEMBLY
2	1	52984	L/H FRONT MUFFLER ASSEMBLY
3	1	52983	R/H FRONT MUFFLER ASSEMBLY
4	1	53048	R/H INTERMEDIATE PIPE ASSEMBLY
5	1	53047	L/H INTERMEDIATE PIPE ASSEMBLY
6	2	90113	S/S ACCUSEAL CLAMP \varnothing 2.50
7	4	90112	S/S ACCUSEAL CLAMP \varnothing 2.25

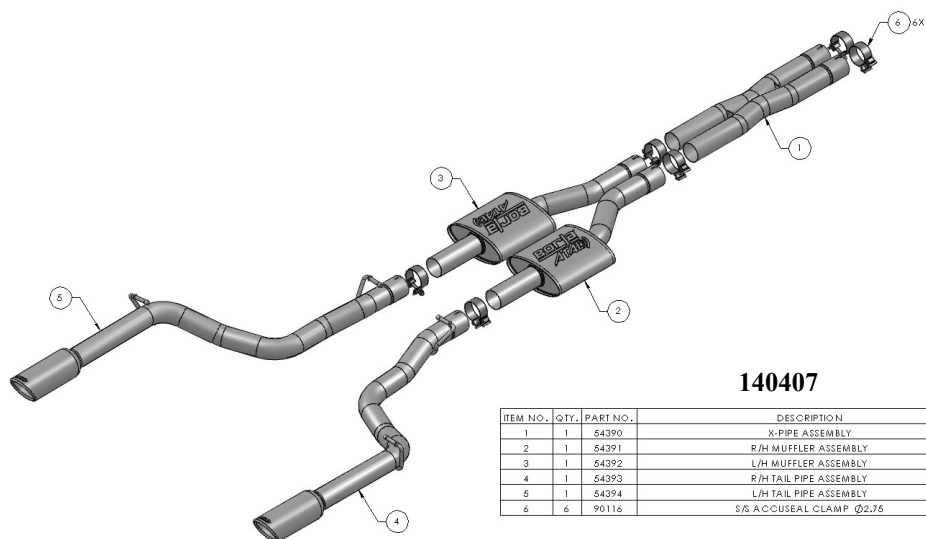

140407

ITEM NO.	QTY.	PART NO.	DESCRIPTION
1	1	54390	X-PIPE ASSEMBLY
2	1	54391	R/H MUFFLER ASSEMBLY
3	1	54392	L/H MUFFLER ASSEMBLY
4	1	54393	R/H TAIL PIPE ASSEMBLY
5	1	54394	L/H TAIL PIPE ASSEMBLY
6	6	90116	S/S ACCUSEAL CLAMP \varnothing 2.75

Caution!!! Never work on a hot exhaust system. Serious injury in the form of burns can result If the vehicle has been in use and the exhaust system is hot, allow vehicle to cool for at least 1 hour. Always wear eye protection when working under any vehicle.

Note: It is our recommendation that you use a hoist or hydraulic lift to facilitate the installation of your new Borla Performance Cat-back™ Exhaust System.

Taking all under car safety precautions, lift the vehicle using a hoist or hydraulic lift. Once this has been done, you may begin the removal of your old exhaust system from your vehicle.

Note: Before removing the original exhaust system from your vehicle, please compare the parts you have received with the bill of materials provided on the previous page to assure that you have all the parts necessary for the installation of your new Borla Performance Cat-back™ Exhaust System.

Original Exhaust System Removal

Note: With a used vehicle, we suggest a penetrating spray lubricant to be applied liberally to all exhaust fasteners and allowing a significant period of time for the chemical to lubricate the threads before attempting to disassemble.

1. Unclip the ground strap from the hanger located on passenger side rear muffler.
2. Unbolt and remove center support bracket shown in figure 1.
3. Lubricate all hangers and rubber brackets.
4. Unbolt flange shown in figure 2 located on driver side of vehicle just behind the front muffler assembly.



Figure 1



Figure 2

5. Using a muffler stand or an additional person to hold the driver side rear muffler assembly up in position, remove the hangers from the rubber brackets and remove the driver side rear muffler assembly from the vehicle.
6. Loosen the clamps shown in figure 3 located just ahead of the h-pipe.

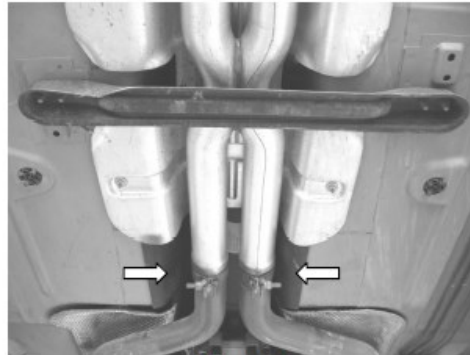

Figure 3

7. Using a muffler stand or an additional person to hold the exhaust up in position, remove the hangers from the rubber brackets and remove the remaining exhaust from the vehicle.

Borla Performance Cat-back™ Exhaust System Installation

*Warning: Use extreme caution during installation. Torque all fasteners according to manufacturer's torque values and tightening sequence. **DO NOT** use air impact tools to tighten fasteners on Borla Performance Exhaust Systems. Use of such tools may result in bent flanges or gasket contact areas leading to exhaust leaks.*

1. Place a clamp over each expanded end of Borla X-pipe assembly and set it into position as shown in figure 4. **DO NOT** tighten the clamps.
2. Place a clamp over the expanded end of left and right front muffler assemblies and set them into position as shown in figure 5. **DO NOT** tighten the clamps.

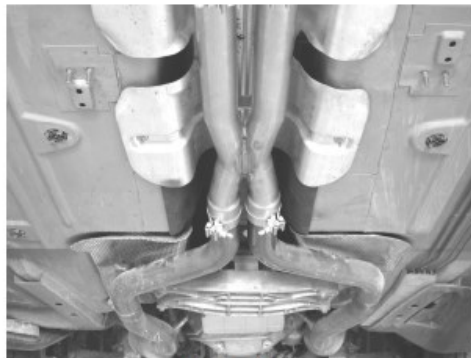

Figure 4



Figure 5

3. Place a clamp over the expanded end of both left and right intermediate/tail pipe assemblies and set them into position as shown in figure 6 installing the hangers into the rubber brackets. **DO NOT** tighten the clamps.

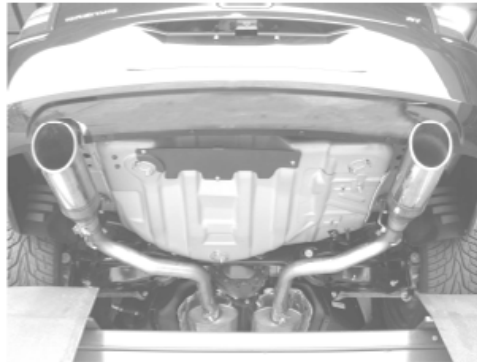

Figure 6

4. Clip the ground strap on to the passenger side rear hanger.
5. Check your exhaust system for proper clearance under the vehicle and also for tip alignment.
6. Once position has been determined to be correct, tighten the Accuseal™ clamps to 32-35 ft. lbs.
7. Using the original hardware, install the center support bracket.
8. Before starting your vehicle, make sure to check all wires, hoses, brake lines, body parts and tires for safe clearance from the exhaust system.
9. Start vehicle and check for any leaks. If any leaks are found, determine cause (such as loose or incorrectly positioned clamp) and repair as necessary.

Note: When you first start your vehicle after the installation of your new Borla Performance Exhaust System, there may be some smoke and fumes coming from the system. This is a protective oil based coating used in the manufacturing of mandrel bent performance exhaust tubing. This is not a problem and will disappear within a very short period of time after the exhaust has reached normal operating temperatures.



Congratulations!!! You have completed the installation of the world famous Borla Performance Stainless Steel Exhaust System.