



Thank you for purchasing a Borla Performance Cat-back™ Exhaust System.

Precision manufactured using aircraft quality T-304 stainless steel; this system is designed to endure years of heavy use. Installing a Borla Performance™ Exhaust System on your vehicle will eliminate the restrictive design of the stock exhaust, allowing your engine to discharge exhaust gas easier. The result is more horsepower and torque, longer engine life, and a distinctive throaty growl- all this, with easy bolt-on installation. These installation instructions have been written to help you in the installation of your Borla Performance™ Exhaust System. Please read it completely before installing your system.

This Borla Performance Cat-back™ Exhaust System (Part number 140048) has been designed for the 2003 thru 2006 Dodge Viper SRT-10 equipped with an 8.3L V-10 engine and a manual transmission. This Cat-back™ Exhaust System has been designed for use with or without the factory cross over pipe.

Note: Use of the factory cross over pipe requires the use of the factory tips. The tip included with your Borla Performance Cat-back™ Exhaust System can only be utilized with the removal of the factory cross over pipe.

Borla Performance Industries recommends that an exhaust shop or professional after market parts installer, who has all the necessary equipment, tools and experienced personnel needed for proper installation, should perform the installation of this system. However, if you decide to perform the installation, we recommend someone should help you. Ensure the installer uses all under car safety precautions including eye protection.

Please take time to read and understand the following...

By installing your Borla Performance Exhaust System, you indicate that you have read this document and you agree with the terms stated below.

It is the responsibility of the purchaser to follow all installation instruction guidelines and safety procedures supplied with your Borla Performance Exhaust System

Borla Performance Industries assumes no responsibility for damages occurring from misuse, abuse, improper installation, improper operation, lack of responsible care, or all previously stated reasons resulting from incompatibility with other manufacturer's products and/or systems.

Included with your Borla Performance Exhaust System is a warranty card. Please read it carefully before you begin any work on your vehicle. If you should have any questions regarding our warranty policy, installation, or any other matter pertaining to your new Borla Performance Exhaust System, please give us a call at the number provided on the warranty card.

Borla Performance Cat-back™ Bill of Materials

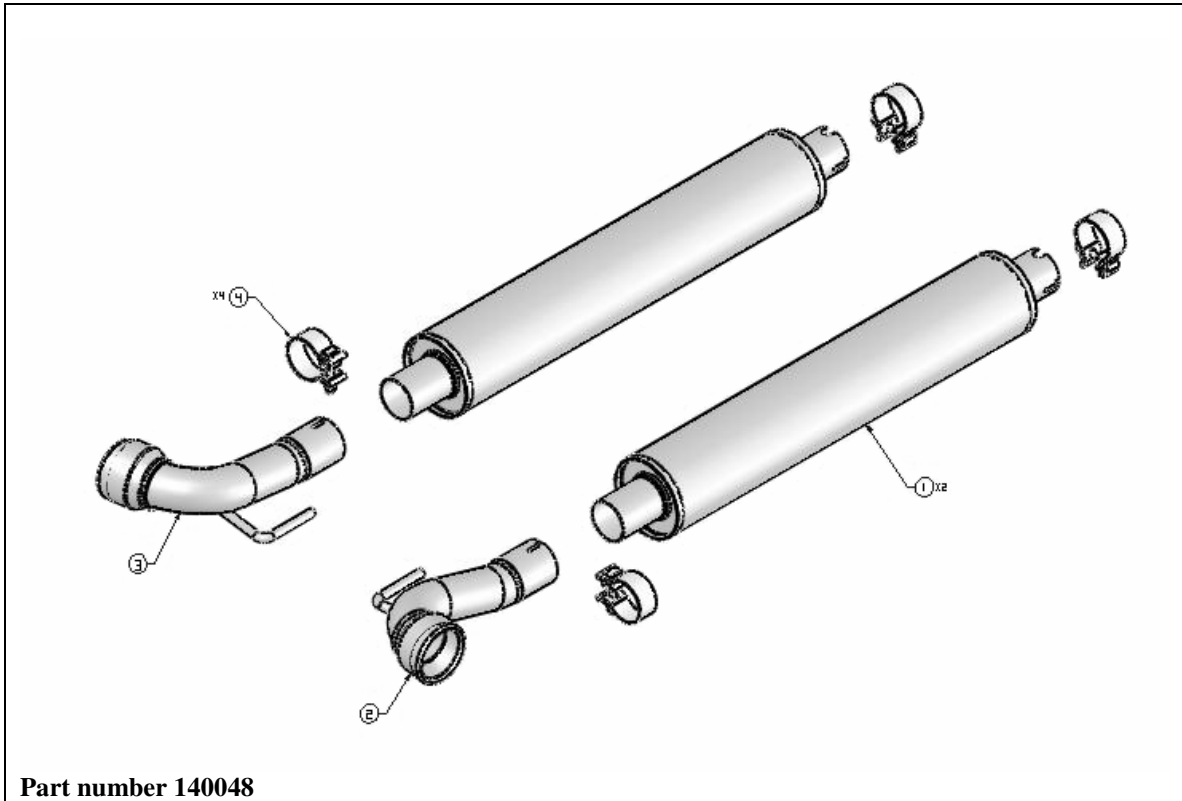

1. Muffler assembly (qty 2)
2. Right turn out assembly
3. Left turn out assembly
4. 2.50" clamp (qty 4)

Caution!!! Never work on a hot exhaust system. Serious injury in the form of burns can result If the vehicle has been in use and the exhaust system is hot, allow vehicle to cool for at least 1 hour. Always wear eye protection when working under any vehicle.

Note: It is our recommendation that you use a hoist or hydraulic lift to facilitate the installation of your new Borla Performance Cat-back™ Exhaust System.

Taking all under car safety precautions, lift the vehicle using a hoist or hydraulic lift. Once this has been done, you may begin the removal of your old exhaust system from your vehicle.

Note: Before removing the original exhaust system from your vehicle, please compare the parts you have received with the bill of materials provided on the previous page to assure that you have all the parts necessary for the installation of your new Borla Performance Cat-back™ Exhaust System.

Original Exhaust System Removal

Note: With a used vehicle, we suggest a penetrating spray lubricant to be applied liberally to all exhaust fasteners and allowing a significant period of time for the chemical to lubricate the threads before attempting to disassemble.

1. Remove each side panel by removing or loosening the hardware listed below. You may want someone to help you to prevent any damage to the side panels.
 - Remove 8 Phillips head screws on the bottom.
 - Remove 3 Phillips head screws in the front wheel well.
 - Remove 1 Phillips head screw in the rear wheel well.
 - Remove 5 Phillips head screws with the door open on the kicker panel.
 - Loosen 2 10mm nuts in the side vent.

Loosening the nuts in the side vents will require some patience, as this is a very tight fit as shown in figure 1. The nuts need only to be loosened as the side panel is slotted.

If you will not be using the factory crossover pipe assembly.

2. Remove the skid plate from the under side of vehicle as shown in figure 2. You will need to remove 20 Torx fasteners using a #40 bit and the 8 Phillips head screws.



Figure 1



Figure 2

3. Loosen the clamps located on each end of the cross over pipe assembly shown in figure 3. There are 4 total.
4. Loosen the clamps shown in figure 4 located behind each muffler assembly.

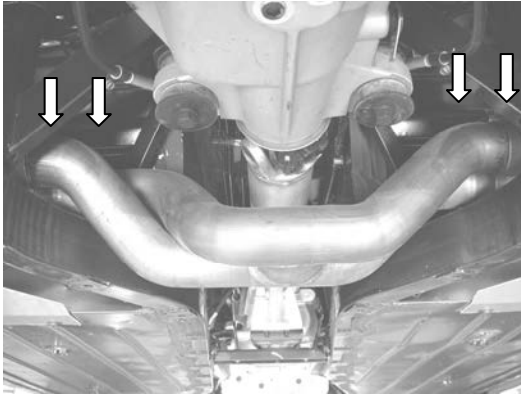

Figure 3



Figure 4

5. Separate each slip fit connection and remove the hanger from the rubber bracket on each side pipe assembly.
6. Remove each side pipe assembly from the vehicle as shown in figure 5.
7. Remove cross over pipe from vehicle as shown in figure 6.
8. Remove each muffler assembly as shown in figure 8.



Figure 5



Figure 6

If you will be using the factory crossover pipe assembly.

Note: Use of the factory cross over pipe requires the use of the factory tips.

1. Loosen the clamps shown in figure 7 located in front of each muffler assembly.
2. Loosen the clamps shown in figure 4 located behind each muffler assembly.
3. Separate the slip fit connections and remove each muffler assembly from the vehicle as shown in figure 8.



Figure 7

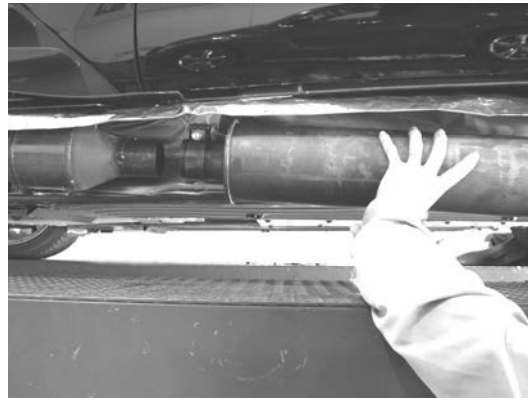

Figure 8

Borla Performance Cat-back™ Exhaust System Installation

Warning: Use extreme caution during installation. Torque all fasteners according to manufacturer's torque values and tightening sequence. **DO NOT** use air impact tools to tighten fasteners on Borla Performance™ Exhaust Systems. Use of such tools may result in bent flanges or gasket contact areas leading to exhaust leaks.

1. Place a clamp over the expanded end of each muffler assembly and set them into position as shown in figure 8. **DO NOT** tighten the clamps.

If you will not be using the factory crossover pipe assembly

2. Place a clamp over the expanded end of each turnout assembly and set them into position sliding over the outlet of each muffler assembly. Install the hanger located on the turnout assembly into the rubber bracket as shown in figure 9. **DO NOT** tighten the clamps.

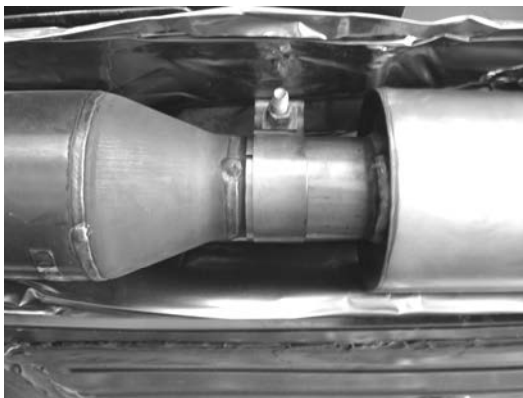

Figure 8

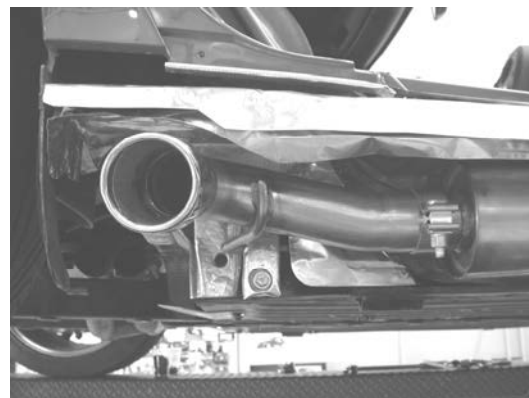

Figure 9

3. Set the side panel into position and move the turnout assembly $\frac{1}{4}$ of an inch from the front of the opening in the side panel as shown in figure 10. This will allow for heat expansion. Remove the side panel and continue on to the installation completion at the bottom of the next page.

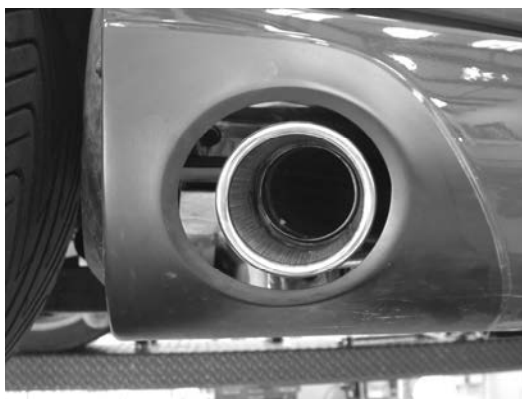

Figure 10

If you will be using the factory crossover pipe assembly

Note: Use of the factory cross over pipe requires the use of the factory tips.

1. Using the original clamps, slide the factory crossover pipe over the outlet of each muffler assembly as shown in figure 11.

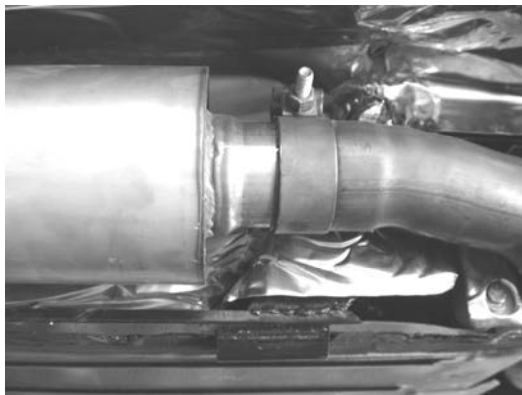

Figure 11

Installation completion for both with and without factory crossover pipe

1. Check your exhaust system for proper clearance under the vehicle and also for tip alignment.
2. Once position has been determined to be correct, tighten the Accuseal™ clamps to 32-35 ft. lbs.
3. Install all body panels and skid plate opposite of removal.
4. Before starting your vehicle, make sure to check all wires, hoses, brake lines, body parts and tires for safe clearance from the exhaust system.
5. Start vehicle and check for any leaks. If any leaks are found, determine cause (such as loose or incorrectly positioned clamp) and repair as necessary.
6. Install body panels in reverse order of removal.

Note: When you first start your vehicle after the installation of your new Borla Performance™ Exhaust System, there may be some smoke and fumes coming from the system. This is a protective oil based coating used in the manufacturing of mandrel bent performance exhaust tubing. This is not a problem and will disappear within a very short period of time after the exhaust has reached normal operating temperatures.